

B&G LCD CHART

USER'S GUIDE AND INSTALLATION

WARNING!

Please read this notice before using the B&G LCD Chart

The electronics chart is an aid to navigation designed to facilitate the use of authorised government charts, not to replace them. Only official government charts and notices to mariners contain all the information needed for the safety of navigation and, as always, the captain is responsible for their prudent use.

**Use of the B&G LCD Chart Implies
knowledge and acceptance of this
warning by the user.**

WARRANTY

1. **Brookes and Gatehouse Ltd.** warrants its products and services to be free of defects in material and workmanship and undertakes to remedy any defects resulting from faulty workmanship, materials or design or failure to perform to specifications.
2. The warranty (parts and labour) is limited to defects encountered during the period of twelve months from the purchase date, but not more than eighteen months from the manufacturing date as determined by **Brookes and Gatehouse Ltd**, whichever comes first.
3. Warranty services (parts and labour) are free of charge for services at **Brookes and Gatehouse Ltd**, or from a **Brookes and Gatehouse Ltd** Authorised Service Centre. The customer is responsible for packing, transportation and insurance charges.
4. The warranty does not cover damages or malfunction caused by the improper use or improper installation, or from routine deterioration due to age, use and marine environmental conditions.
5. **Brookes and Gatehouse Ltd.** assumes no obligation or warranty for products, other than those mentioned above, and in all cases is not responsible for direct or indirect damages of any kind, including loss, damages relative to use (or lack of) of the product and or services by **Brookes and Gatehouse Ltd**, or damages of any kind claimed by third parties, except where limited by law.
6. The use of **Brookes and Gatehouse Ltd**, products and/or services implies complete acceptance of the above listed conditions by the user.

Brookes and Gatehouse LCD Chart

All rights reserved. No part of this publication may be reproduced in any form or by any means without prior consent in writing.

Part 1 - Introduction

The ***B&G LCD Plotter*** is a fully integrated chart plotting system which displays information combined from your position fixer and instrument system (if available), and presents it in a flexible but easy to use format. Information is fed from your position fixer and/or instrument system and may be viewed in a choice of display configurations.

Flexible, user friendly software allows for easy programming and operation. To access a chart, simply install a Navionics MICROCHART™, then using the cursor buttons, zoom into any degree of detail from an overall view to a close up showing objects as small as 3m (10 ft) in size.

Part 2 - OPERATING INFORMATION

CONTENTS

Para		Page
2.1	The Keyboard	2-4
2.2	Quick Tour	2-5
2.3	Functional Characteristics	2-7
2.3.1	<i>navigation and cursor mode</i>	2-7
2.3.2	<i>autozoom</i>	2-7
2.3.3	<i>contrast</i>	2-8
2.3.4	<i>illumination</i>	2-8
2.3.5	<i>screen amplifier</i>	2-8
2.3.6	<i>overzoom</i>	2-8
2.4	Inserting a <i>Microchart</i> [™]	2-9
2.5	Removing a <i>Microchart</i> [™]	2-9
2.6	Chart Information	2-9
2.7	Using the Zoom Key	2-10
2.8	Displaying Chart Details	2-10
2.9	Displaying Navaid Information	2-10
2.10	Displaying Port Services	2-11
2.11	Information Windows in Cursor Mode	2-12
2.11.1	<i>no route present</i>	2-12
2.11.2	<i>route present</i>	2-12
2.11.3	<i>waypoint editing</i>	2-12
2.11.4	<i>navaids window</i>	2-13
2.12	Information Windows in Navigation Mode	2-13
2.12.1	<i>speed windows</i>	2-13
2.12.2	<i>navigation window</i>	2-14
2.12.3	<i>data window</i>	2-15
2.13	Routes	2-15
2.13.1	<i>route elements</i>	2-15
2.13.2	<i>marker</i>	2-16
2.13.3	<i>track</i>	2-16
2.13.4	<i>boat position</i>	2-16
2.13.5	<i>rubber banding</i>	2-16
2.13.6	<i>leg</i>	2-16
2.13.7	<i>waypoint</i>	2-16
2.13.8	<i>cursor</i>	2-16
2.14	Plotting a Route	2-17
2.14.1	<i>create or edit</i>	2-17

CONTENTS (Contd)

2.14.2	<i>delete last waypoint</i>	2-17
2.14.3	<i>deleting a waypoint</i>	2-17
2.14.4	<i>deleting all waypoints</i>	2-17
2.14.5	<i>moving a waypoint</i>	2-17
2.14.6	<i>inserting a waypoint</i>	2-18
2.15	Changing a Route during Navigation	2-18
2.15.1	<i>changing target waypoint</i>	2-18
2.15.2	<i>deleting all waypoints</i>	2-18
2.16	Route Functions from the Main Menu	2-18
2.16.1	<i>route information</i>	2-18
2.16.2	<i>entering the power and speed</i>	2-19
2.17	Managing Routes	2-19
2.17.1	<i>storing a route</i>	2-19
2.17.2	<i>recalling a route</i>	2-20
2.17.3	<i>deleting a route</i>	2-20
2.17.4	<i>reversing a route</i>	2-20
2.18	Tracks	2-20
2.18.1	<i>switching a track on</i>	2-21
2.18.2	<i>switching a track off</i>	2-21
2.18.3	<i>tracking density</i>	2-21
2.18.4	<i>storing a track</i>	2-21
2.18.5	<i>deleting one track</i>	2-21
2.18.6	<i>deleting all tracks</i>	2-22
2.18.7	<i>recalling a track</i>	2-22
2.19	Marks	2-22
2.19.1	<i>inserting a mark</i>	2-22
2.19.2	<i>deleting a mark</i>	2-22
2.19.3	<i>storing a mark</i>	2-22
2.19.4	<i>recalling a mark</i>	2-23
2.19.5	<i>deleting all marks</i>	2-23
2.20	GO TO Function	2-23
2.20.1	<i>go to a waypoint</i>	2-23
2.20.2	<i>go to a mark</i>	2-23
2.20.3	<i>go to a lat/lon</i>	2-23
2.20.4	<i>go to nearest. . .</i>	2-24
2.20.5	<i>go to a port</i>	2-24
2.21	Display Log	2-25
2.21.1	<i>status page</i>	2-25

CONTENTS (Contd)

2.21.2	<i>depth page</i>	2-25
2.21.3	<i>speed page</i>	2-25
2.21.4	<i>true wind log</i>	2-26
2.21.5	<i>position log</i>	2-26
2.22	Position Offset Calibration	2-26

PART 2 - OPERATING INFORMATION

2.1 The Keyboard

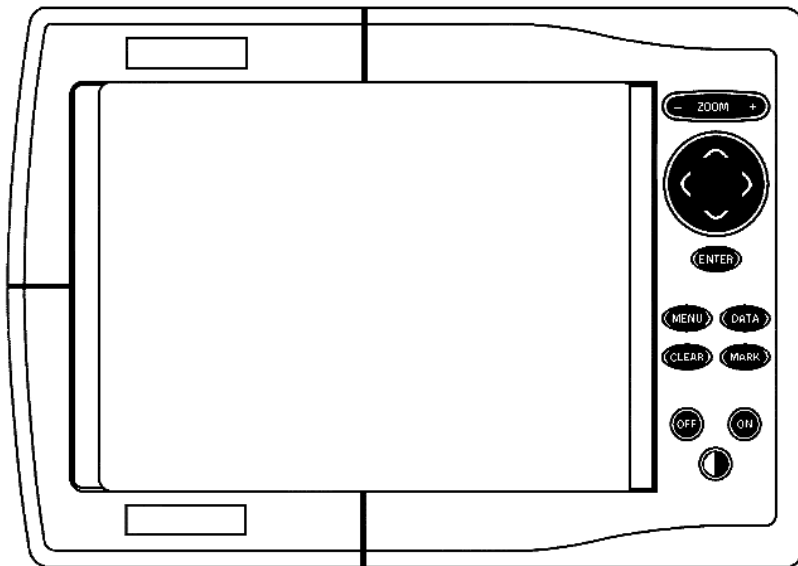

B&G LCD Chart Plotter



Zoom +/-

- increases or decreases the chart range
- activates and deactivates the Autozoom feature



Cursor Keys

- provides cursor control in all directions
- allows selections in Menu windows
- selects Automatic Mode or Manual Mode of operation



Enter Key

in manual mode:

- inserts a waypoint at the cursor position

within menus:

- confirms a selection

in automatic mode:

- changes the target waypoint



Menu Key

- displays the main menu bar across the top of the screen
- displays route information from the data window
- configures speed during route planning



Data Key

- selects page of information containing navigational data
- returns to the map
- deletes the last route segment
- aborts a function that is not required



Clear Key

- deletes individual waypoints
- deletes routes
- deletes markers



Mark Key

- inserts a marker at the cursor or boat position



On Key

- switches unit on
- adjusts illumination setting



Contrast Key

- adjust contrast level in conjunction with left/right cursor keys

2.2 Quick Tour

The default language for the *B&G LCD Plotter* is English. Should you wish to change this, press the MENU key to access the main menu. Using the cursor, select SETUP, and then scroll down to highlight LANGUAGE. Select the desired language by using the left/right cursor keys and press the DATA key to exit.

To quickly gain confidence using the *B&G LCD Plotter*, use it intuitively. No damage may occur by pressing an incorrect button. For correct operation, ensure your GPS is switched on, insert a chart cartridge and press the ON key. After a short introductory screen, press the ON key once to activate screen illumination. Repeatedly press the ON key to select the desired intensity setting. Press any other key, except OFF, to continue.

B&G LCD Plotter
Part 2 - Operating Information

Once your GPS has obtained a lock, the area relative to the boat position is automatically displayed in the most suitable zoom scale. The boat's position is indicated by a circle with a cross-hair. The straight line protruding from the centre is the boat's heading vector and indicates the boat's course over ground; this should be ignored if the boat is stationary.

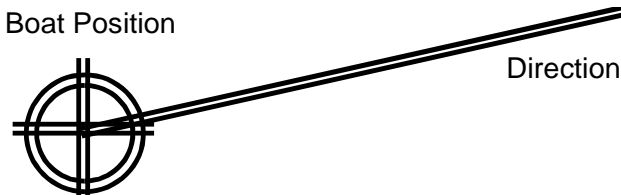

Two windows appear, the first one contains the boat's position, date, time, fix, satellite numbers, depth and magnetic variation. The second window shows the speed, course and chart range. Press the DATA key repeatedly to alternate between the data window and the navigational window (*LCD Plotter* is in navigation mode).

To create a route, press one of the cursor keys. It is now possible to move the cursor in any direction. A constant connection is made between the boat's present position and the cursor by way of an 'elastic band'. The geographic position of the cursor is given by the point of intersection of the two lines and is shown in the data window. This data window also shows the distance of the cursor from the boat's present position.

Move the cursor to the first waypoint location and press the ENTER key. This waypoint position will be shown as a small black circle with a number located in it. This is your first waypoint location.

To exit the cursor screen, press the DATA key. The navigational data window now shows the distance to waypoint and time to reach the new waypoint. Also shown is the arrival time and the chart range.

To add more waypoints, simply move the cursor to the position you require, and then press ENTER. Should you make a mistake, press the CLEAR key (cursor mode only, in navigation mode, CLEAR deletes the entire route) to delete the required waypoints and relative segments, beginning with the last waypoint entered. When you have finished, press the DATA key.

The *LCD Plotter* will emit an audible alarm along with text confirmation when the target waypoint has been reached.

The navigational data window will display the boat's velocity and direction of navigation with respect to the ground (not compensating for errors caused by tidal currents, wind, or magnetic deviations), bearing, distance, and time to next waypoint.

2.3 FUNCTIONAL CHARACTERISTICS

Descriptions used for operating the *B&G LCD Plotter*.

2.3.1 Navigation mode and cursor mode (AUTO & MANUAL mode)

The *LCD Plotter* is already in navigation mode when it is first switched on and when the cursor is not present. The navigation mode is the normal setting used during navigation. In this mode it is possible to do quick editing operations (i.e., change waypoint, delete waypoint, delete route) by using the CLEAR key.

To change to cursor mode, simply press the cursor key to activate the cross-hair. This mode of operation is used to insert and delete markers, and for viewing navaid information etc. The information windows shown are different for each mode. Pressing the DATA key toggles between cursor mode and navigation mode.

2.3.2 Autozoom

This function automatically zooms the image to the best scale available; that is, the boat position to the next waypoint in the route. To deactivate Autozoom, press and hold the ZOOM+ key to the desired scale. To reactivate Autozoom, press and hold the ZOOM+ key until AUTOZOOM is highlighted and then release. When the *LCD Plotter* is first switched on, if a route is already shown on the screen from a previous day's navigating, and the GPS has a lock, Autozoom is automatically selected.

2.3.3 Contrast

Press the CONTRAST key to open the contrast window. Adjust the contrast to the desired setting by pressing the left/right cursor keys. Press the ENTER key to exit the contrast function.

2.3.4 Illumination

To alter the illumination level, repeatedly press the ON key until the desired level is obtained. The *LCD Plotter* has eight levels of illumination.

2.3.5 Screen Amplifier

The *LCD Plotter* is constantly monitoring the orientation of the boat. With the Screen Amplifier on, 75% of the *LCD Plotter's* screen is dedicated to the area in front of the boat. To activate/deactivate the Screen Amplifier, press the MENU key. Next, press the left/right cursor keys and select SETUP. Now, scroll down to highlight SCREEN AMPLIFIER, and then use the cursor left/right keys to select ON or OFF. Press ENTER to accept.

2.3.6 Overzoom

The overzoom feature does not show a higher level of detail, but increases the viewing of pre-existing information. Its operation maybe likened to a magnifying glass.

CHARTS

INTRODUCTION

The *LCD Plotter* comes with a map of the World already loaded into its memory. It is possible to zoom onto any point on this map in scales ranging from 4,096 to 512 NM (nautical miles). For better chart detail, use a Navionics Seamless memory cartridge of the area of navigation.

2.4 Inserting a Microchart[®]

<p>Note: Only insert or remove chart cartridges when the instrument is switched OFF</p>
--

Remove the rubber cap covering the socket on the right hand side of the casing. Then, ensuring that the Navionics logo is facing towards you, push the cartridge firmly into the socket.

2.5 Removing a Microchart[®]

Remove the rubber cap and press the button that is found in the top part of the internal socket containing the cartridge. When the plotter is turned on,

but not connected to the GPS, the first cartographic image will be a large panorama centred on Africa, independent of the cartridge inserted. A small square indicates the limits of the cartridge currently inserted. Press the CURSOR key to move the cursor within the square and successively zoom as desired.





If the LCD Plotter is connected to a GPS, the image automatically centres on the boat position in the 4 NM scale. If a route is already shown on the display, the autozoom function is automatically selected.

The maximum level of detail corresponds to that of a port plan and is approximately equivalent to one metre per pixel or 1/8 NM.

Always verify that the rubber cap is completely sealed, especially if the LCD Plotter is installed outside, as water may damage the memory card. Only remove the rubber cap when the instrument is dry.

2.6 Chart Information

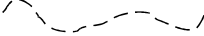
Navionics charts contain the following types of symbols:

100	Spot Depth
	Shipwreck
	Navigational Aid: Lights
	Depth Contour
	Port Services

2.7 Using the Zoom Key

To increase or decrease the coverage shown on the LCD Plotter screen, press and hold the ZOOM +/- key and release at the desired setting.

2.8 Displaying Chart Details

Information may be switched on or off to greatly enhance the viewing of the area currently being navigated. This is especially useful in ports and harbours where there are numerous depth contours etc. Navigational aids which may be switched on or off are as follows: depth contours, names, nav aids, and the land fill capability. To switch a Navaid on or off, observe the following procedure:

- 1) Press the MENU key
- 2) Use the CURSOR key to highlight SETUP from the menu
- 3) Use the CURSOR up/down keys to select desired function
- 4) Use the CURSOR left/right keys to select ON or OFF from the menu
- 5) Press ENTER to accept

2.9 Displaying Navaid Information (Lights)

To display navaid information, move the CURSOR over the light symbol (ensure NAVAIDS is switched to ON in the setup menu). A window will now be displayed showing the position and characteristics of the light.

Description of light characteristics:

Abbreviations for Light		Abbreviations for Colour	
AL	Alternating	AM	Amber
F	Fixed	B	Black
FLL	Fixed and Flashing	BL	Blue
FL(..)	Group Flashing	G	Green
FL	Single Flashing	OR	Orange
IQ	Interrupted Quick	R	Red
OC	Single-Occulting	VL	Violet
OC(..)	Composite Group Occulting	W	White
Q	Continuous Group	Y	Yellow

Abbreviations for Period		Abbreviations for Range	
..S	xx seconds	..M	xx nautical miles

2.10 Displaying Port Services

Entering in a port, place the cursor on the sail boat shown on the map (zoom minimum 1 NM) and press the ENTER key to open the information window.

This window will display different icons which represent the services provided by the port. Select the icon with the CURSOR key. The number of the icons shown is dependent on the services provided by that port.

These icons open a list of services provided by the particular port.



(a)



(b)



(c)



(d)



(e)



(f)



(g)

- (a) Information and port authorities
- (b) Sanitary and first aid services
- (c) Customer services
- (d) Tourist services and shops
- (e) Fuel
- (f) Water
- (g) Engine, boat and electronic servicing

Note

Port Services are available on supported Microchart™ cartridges only. Please contact your Navionics stockist for further information.

2.11 INFORMATION WINDOWS IN CURSOR MODE

The LCD Plotter will display different windows depending on whether the unit is operating in cursor mode (cross-hair shown) or navigation mode.

2.11.1 No Route Present in Cursor Mode

- Total route length
- Time enroute (with the set speed)
- Distance from the last waypoint to the cursor
- Cursor position
- Chart range

2.11.2 Route Present in Cursor Mode

- Range, from the boat position to the cursor
- Time enroute (true boat speed)
- Bearing
- Cursor position
- Chart range

2.11.3 Waypoint Editing

If the cursor is placed over a waypoint, a window will appear prompting you to either delete the waypoint or move it. Press the ENTER key to move it, or press the CLEAR key to delete it.

By pressing the ENTER key, to move a waypoint, this window will display the following information:

- Cursor position (the position will change until the waypoint is fixed by ENTER)
- Chart range

When the cursor is placed on a segment of the route, a window is displayed showing the two waypoints placed at the extremities of the segment; by pressing the ENTER key, it is possible to insert a new waypoint. After a waypoint is inserted, this window gives the co-ordinates relative to the new waypoint.

2.11.4 Navaid Window

If the cursor is moved over a navaid, a window will be displayed showing:

- The Latitude/Longitude of the selected navaid
- The characteristics for the navaid

2.12 INFORMATION WINDOWS IN NAVIGATION MODE

Press DATA to display the following windows:

2.12.1 Speed Windows



If no route is plotted, this small window will appear containing only the boat speed (knots), the course and chart range.

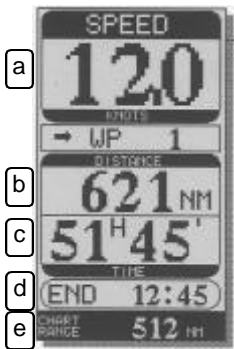

The calculation of time of travel is based upon information previously collected from the data input.

- a) - Speed over ground in knots
- b) - Distance to the next waypoint
- c) - Time to reach next waypoint from present position
- d) - Arrival time
- e) - Chart range

B&G LCD Plotter
Part 2 - Operating Information

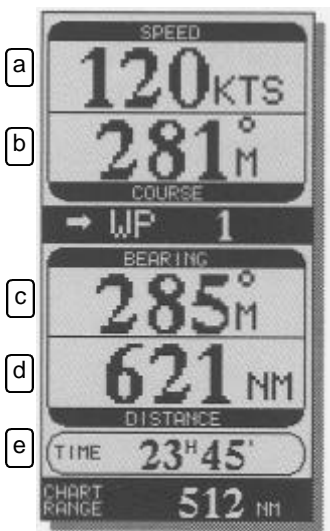

- a) - Speed over ground
- b) - Course
- c) - Waypoint bearing (of the target waypoint)
- d) - Distance to the next waypoint
- e) - Time to reach the next waypoint
- f) - Chart range

2.12.2 Navigation Window

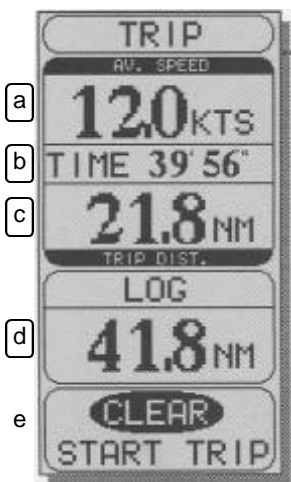

Displays information of the complete trip.

- a) - Average speed
- b) - Time from departure
- c) - Trip distance (previous distance from departure)
- d) - Total distance
- e) - Clear to start trip

2.12.3 Data Window

a	26 OCT 96	
	17:36:45	
b	33°45944' S	
	17°36672' E	
c	FIX OK	SATS 6
d	DEPTH METERS	MAG. VAR 0° A

Displays information of the current position of the boat (active only when the GPS is connected).

- a) - Day, month, year, local or Greenwich Mean Time
- b) - Boat position
- c) - GPS Status and number of satellites. This will be replaced with DIFF if interfaced to a GPS Differential system.
- d) - Units of depth measurement, value of magnetic variation and method used

2.13 ROUTES

2.13.1 Route Elements

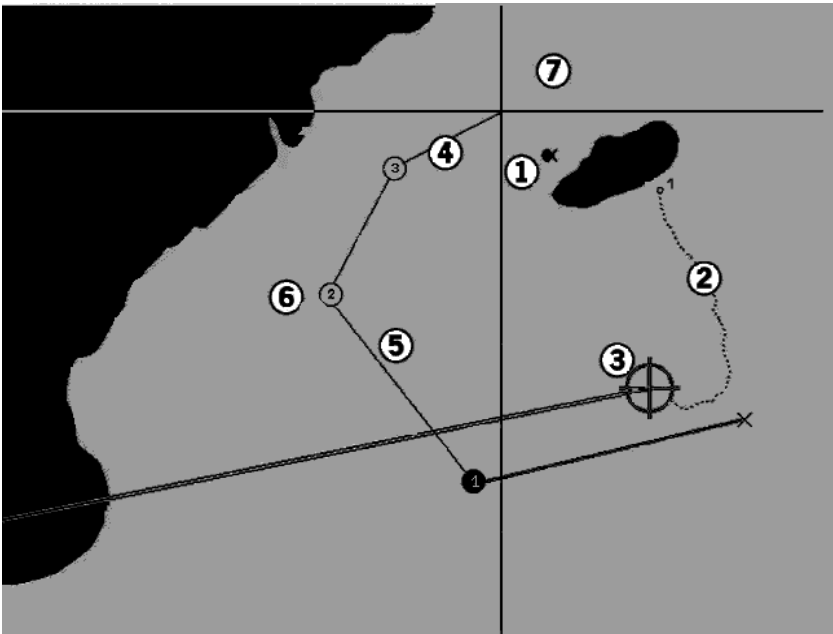

2.13.2 Marker (1)

Indicates a point of interest and is designated by a user-defined symbol (up to 5), name (up to 8 characters) and/or a number.



2.13.3 Track (2)

Indicates the course travelled by the boat with a dashed line.

2.13.4 Boat Position (3)

Shows the position as read by the GPS.

2.13.5 Rubber Banding (4)

This is a line that maintains a connection between the last waypoint and the cursor, or the boat position and the cursor when no waypoint is inserted. It displays a proposed new route segment before selection. It can be eliminated by pressing the DATA key.

2.13.6 Leg (5)

A leg is the portion of a route contained between 2 waypoints.

2.13.7 Waypoint (6)

Indicates an important point in the route (often one in which a turn is made) and is represented by a number. An audible alarm and the message "PROXIMITY TO WAYPOINT" inform the user 25 seconds before the waypoint is reached. At the last waypoint the message is "End of route". The departure waypoint is represented by the symbol "X". The target waypoint (the next point toward which one is navigating) is a black circle.

2.13.8 Cursor (7)

Indicates a position in geographic co-ordinates in the appropriate data window. It disappears when the plotter is working in navigation mode. To

make it reappear, press the CURSOR key. To deactivate it, press DATA. The unit is in editing mode when the cross-hair is displayed.

2.14 PLOTTING A ROUTE

2.14.1 Create or Edit

Move the cursor with the arrow keys to the desired position, press the ENTER key to insert the waypoint. Move the cursor to the next position and press ENTER to insert the second waypoint. Repeat this procedure for the remaining waypoints in your route. Up to 40 waypoints maybe entered per route.

2.14.2 Delete Last Waypoint

Press the CLEAR key. If the last waypoint is placed out of the screen, the message "LAST WAYPOINT OUT OF SCREEN!" will appear.

2.14.3 Delete a Waypoint

Position the cursor with the arrow keys on the waypoint to delete and press CLEAR.

2.14.4 Delete all Waypoints

Press the CLEAR key repeatedly until the message "NO MORE WAYPOINTS" is displayed.

2.14.5 Moving a Waypoint

Position the cursor (cross-hair) with the cursor keys onto the waypoint to be moved. The waypoint will begin to flash. Press the ENTER key to select the waypoint and using the cursor keys, position the waypoint to the new location. Press the ENTER key again. A help window gives the current cursor position and facilitates the operation.

2.14.6 Inserting a Waypoint

Move the cross-hair cursor to the selected route segment to insert the new waypoint. The route segment will begin to flash when the cross-hair is placed over the segment. Next, press ENTER to display the new waypoint

and use the cursor keys to position to the required location. Finally, press the ENTER key to store.

2.15 CHANGING A ROUTE DURING NAVIGATION

The cursor must not be present; if it is displayed, press the DATA key before performing the following operations.

2.15.1 Changing Target Waypoint

Press the ENTER key and a window will appear. Select the waypoint with the cursor. The route will be tracked on this new waypoint and the previous ones will be deleted.

2.15.2 Deleting all Waypoints

Press the CLEAR key for two seconds. The message "ROUTE WILL BE DELETED! ARE YOU SURE?" will be displayed. Confirm this by pressing the ENTER key or to exit, press any other key.

Other Route functions are available through the Go To sub-menu. Refer to section 2.20 for further details.

2.16 ROUTE FUNCTIONS FROM THE MAIN MENU

2.16.1 Route Information

Route Information (Route Info. . .) has two pages, one containing the specific fields, the second containing all the waypoint co-ordinates. Press the MENU key and use the CURSOR key to highlight ROUTE. Select INFO, and press ENTER to display a window that shows the incremental route data in column form.

WP N.	numbering of waypoints
DIST LEG	segment length or rather the distance between the preceding waypoint and the next waypoint
DIST TOT	incremental length from the departure point
HEADING MAG	magnetic course (true route corrected for magnetic declination)
TIME ENROUTE	time of navigation
FUEL #	fuel consumption

WP N.	DIST LEG NM	DIST TOT NM	HEADING MAG.	TIME ENROUTE	FUEL LITERS
START	---	---	---	---	---
01	1165	1165	2381° _N	56' 50"	36 L
02	9.67	2132	1426° _N	1 ^H 43'	66 L
03	1396	3527	841° _N	2 ^H 52'	109 L
04	9.88	4515	00° _N	3 ^H 40'	139 L
END	1005	5520	2843° _N	4 ^H 29'	171 L

↑↓	CHANGE PAGE	
ENTER	INPUT SPEED & POWER	SPEED = 120 KTS
DATA	EXIT	POWER = 200 HP

Press the up/down CURSOR keys to toggle to the next page which displays a progressive list of waypoints with relative position. The data relative to time enroute and fuel consumption is displayed only after inserting and saving the value for cruise velocity and that for engine power used in those speed conditions. Press any other key to exit.

2.16.2 Entering the Power and Boat Speed

Press the MENU key and select ROUTE. Select INFO and press ENTER twice to open the two relative setting windows. Use the arrow keys to insert the data and press ENTER to confirm.

2.17 MANAGING ROUTES

2.17.1 Storing a Route

To store a route, press the MENU key and select ROUTE. Next, select STORE to open the memory catalogue. The memory catalogue provides you with 10 locations allowing you to store 10 independent routes. Initially, location '01' will be selected. Subsequent routes may then be stored in the next free location or alternatively, to overwrite a previously entered route. Should all ten locations have routes stored in them, you are then offered the choice of locations one through to ten.

B&G LCD Plotter

Part 2 - Operating Information

To name the route, simply use the up/down CURSOR keys to select the name and the left/right CURSOR keys to select the location. Upon completion, press the ENTER key to confirm.

2.17.2 Recalling a Route

Press the MENU key and select ROUTE from the options. Next, select RECALL and use the CURSOR key to choose the desired route. Press the ENTER key to confirm.

A start from window will appear to insert the starting waypoint. This window will disappear after 5 seconds if no waypoint is inserted. If no route is present in the catalogue, the message "no routes stored" will appear.

2.17.3 Deleting a Route

Press the MENU key and select ROUTE. Next, select DELETE and the message "ROUTE WILL BE DELETED! ARE YOU SURE?" will appear. Confirm with ENTER or exit with any other key. If no route is stored, the message "NO WAYPOINTS PRESENT!!!" will appear.

2.17.4 Reversing a Route

Press the MENU key and select ROUTE. Choose REVERSE with the CURSOR keys and press ENTER to confirm. A window will appear, select the waypoint with the cursor. The order of the waypoints displayed on the screen will be reversed, starting from the selected one. If no waypoint is inserted, this window will disappear after 5 seconds. To see all of the details for this new configuration, re-open the route information window.

2.18 TRACKS

A track is the course of the boat. Track related operations are activated from the main menu.

2.18.1 Switching a Track ON

Press the MENU key and select TRACK from the menu bar. Choose TRACK START and confirm with the ENTER key. The message "TRACK STARTED" will appear to confirm the operation.

2.18.2 Switching a Track OFF

Press the MENU key and select TRACK from the menu bar. Select TRACK STOP and confirm with the ENTER key. The message "TRACK STOPPED" will appear to confirm the operation.

When selecting START TRACK, a number will appear on the course; selecting STOP TRACK will cause the tracking to stop; selecting START TRACK again will cause a sequential number to appear, etc.

2.18.3 Setting the Tracking Density

Press MENU and select SETUP. Choose TRACKING DENSITY, and move the box to DIST or TIME. A new box will appear prompting you to enter distance increments of 0.01NM or time increments of 30 seconds up to 5 minutes. Press the ENTER key to accept. The AUTO selection will automatically choose the time and distance increments for you.

Note: the more time or distance segments that are selected will cause the memory to fill at a faster rate. When the limit is reached, the message "TRACK FULL" will be displayed. To continue tracking, press the MENU key, select TRACK, select STORE and then press ENTER to confirm.

2.18.4 Storing a Track

Press the MENU key and select TRACK. Next, select STORE to open the memory catalogue and select the location with the CURSOR and insert the name. Press ENTER to confirm or any other key to exit. The message "TRACK STORED" will appear to confirm the operation.

2.18.5 Deleting One Track

Press the MENU and select TRACK. Next select DELETE 1 TRACK to open the delete one track window. Use the CURSOR key to choose the Leg number to delete. It is possible to delete one track or a part of it (one or more legs). The message "TRACK WILL BE DELETED! ARE YOU SURE?" will appear. Press ENTER to confirm or any other key to exit.

2.18.6 Delete All Tracks

Press the MENU key and select TRACK. Next, select DELETE ALL TRACKS, to open the delete all tracks window. The message "ALL TRACKS WILL BE DELETED, ARE YOU SURE?" will appear. Confirm by pressing ENTER or exit with any other key.

2.18.7 Recalling a Track

Press the MENU key and select TRACK. Next, select RECALL to open the track catalogue and then select the track with the CURSOR keys. Confirm by pressing ENTER or exit with any other key. If no tracks are present in the catalogue, the message "NO TRACKS STORED" will appear.

2.19 MARKS

2.19.1 Inserting a Mark

Place the cursor on the selected point and press the MARK key. A window will open in which to insert the name. Move inside this window using the CURSOR key. Confirm by pressing ENTER or exit with any other key.

2.19.2 Deleting a Mark

Position the cursor using the CURSOR keys on the mark and press CLEAR.

2.19.3 Storing a Mark

Press the MENU key and select MARKS. Next, select STORE and press ENTER to confirm. The memory catalogue will appear containing a name by default. To name the mark, use the up/down CURSOR keys to choose the letter and the left/right keys to choose the position. Confirm this function by pressing the ENTER key; the message "MARK STORED" will be displayed as confirmation.

2.19.4 Recalling a Mark

Press the MENU key and select MARKS from the menu bar. Next, select RECALL and press ENTER. In the markers catalogue, select the mark and press ENTER to confirm. The LCD Plotter will place the cursor on the mark, the scale will be 4 NM (if available on the chart) and the relative window will appear. If no markers are present in the catalogue, the message "NO MARKERS STORED" will appear.

2.19.5 Deleting All Markers

Press the MENU key and select MARKS. Next, select DELETE and press ENTER. The message "ALL MARKERS WILL BE DELETED, ARE YOU SURE?" will appear. Confirm by pressing ENTER, or exit with any other key. In either choice, only the markers present on the screen are deleted.

When markers are not previously stored, the message "NO MARK PRESENT !" will appear.

2.20 GO TO FUNCTIONS

2.20.1 Go To a Waypoint

Press the MENU key and select GO TO from the menu bar. Next, select WAYPOINT and press the ENTER key to open the GO TO waypoint window. Select the waypoint and confirm by pressing ENTER or press any other key to exit. The LCD Plotter will track the route to reach the selected waypoint. This waypoint will be the new target waypoint. The progressive number will be changed, starting from the selected waypoint that will become number one. The previous waypoint will be deleted. If no waypoints are stored the message "NO WAYPOINTS PRESENT !" will appear.

2.20.2 Go To a Mark

Press the MENU key and select GO TO from the menu bar. Next, select MARK and press ENTER to open the mark catalogue. Select the mark and press ENTER to confirm or press any other key to exit. The LCD Plotter will display the cursor placed on the mark with the relevant window. The scale will be 4 NM (if available on the chart). If no mark is stored the message "NO MARK PRESENT !" will appear.

2.20.3 Go To LAT/LON

Press the MENU key and select GO TO from the menu bar. Select LAT/LON and press ENTER to open the GO TO window. To input the position use the cursor key and press ENTER to confirm or any other key to exit. The LCD Plotter will display the cursor placed on the selected position at the maximum zoom with the relative information window.

2.20.4 Go To Nearest. . .

This option gives the possibility to reach the nearest port, which can provide different services, from the target waypoint (with GPS on and a route already tracked).

Press the MENU key and select GO TO from the menu bar. Next, select NEAREST and press ENTER to open the nearest window. Using the CURSOR keys, select the icon you require and confirm by pressing the ENTER key.

The LCD Plotter will display 3 flashing icons on the 3 closest ports. The closest service is labelled by a double frame, a window is displayed containing the relative port name (framed), the distance and time (set time) to reach it.

It is possible to select any of the 3 ports with the CURSOR key (for any selection a waypoint is given to show the possible route), press ENTER to confirm or any other key to exit. The target waypoint will be changed, the new one will be the selected port and the LCD Plotter will track the new route to reach it. The previous route will be erased from the screen but not cancelled from the memory.

2.20.5 Go To a Port

Press the MENU key and select GO TO from the menu bar. Next, select PORT and press ENTER to confirm. A window will display all the ports included in the current chart. Select one port with the arrow keys and press ENTER to confirm. The cursor will now be placed on the selected port and the geographical co-ordinates will be shown in the window.

Press the ZOOM+ key until 1NM range is selected to display the port map. Press ENTER to view all the services contained in this port. Use the CURSOR key or the ZOOM key to go to another page or return to the previous one.

2.21 DISPLAY LOG

The B&G LCD Chart Plotter has five dedicated pages for collectively displaying instrument and positional data. To access these pages, first press the MENU button. Next, using the CURSOR left/right keys, highlight MAPS from the menu bar. Finally, press the DATA key to enter the Display

Log pages. Successive presses of the DATA key will scroll through each page in turn.

2.21.1 Status Page

This page conveniently displays instrument and satellite data onto one screen. The information presented here is dependent upon what instruments are connected to the LCD Plotter. Providing the GPS has a lock, the minimum information displayed will be the number of satellites acquired by the GPS and the HDOP (Horizontal Dilution Of Position) value.

2.21.2 Depth Log

The Depth Log shows depth readings in a graphical format. Providing the LCD Plotter is connected to a suitable display transmitting depth information, this data is continually logged and then may be displayed over a set period of time ranging from the previous 3-24 hours. Pressing the ZOOM +/- keys changes the time period.

An instantaneous depth reading may be obtained by moving the time line with the CURSOR left/right keys. This depth is then displayed at the top of the chart.

2.21.3 Speed Log

The Speed Log shows speed readings in a graphical format. Providing the LCD Plotter is connected to a suitable display transmitting speed information, this data is continually logged and then may be displayed over a set period of time ranging from the previous 3-24 hours. Pressing the ZOOM +/- keys changes the time period.

An instantaneous speed reading may be obtained by moving the time line with the CURSOR left/right keys. This speed is then displayed at the top of the chart.

2.21.4 Wind Log

The Wind Log can display graphically Apparent Wind information or True Wind information dependent on the data being received at its NMEA input port. True wind speed and true wind direction data requires boat speed and heading to be input in addition to apparent wind speed and angle. Apparent wind angle is shown in the format 0-180 L or R whilst true wind direction is shown as 0-359° M.

B&G LCD Plotter
Part 2 - Operating Information

Pressing the Zoom +/- keys changes the time period displayed between the last 3-24 hours. Instantaneous wind speed and direction values may be obtained by moving the time line. To do this, press the CURSOR left/right keys accordingly.

2.21.5 Position Log

The Position Log monitors your position and stores this in 30 minute intervals. These intervals start from the moment that your GPS acquires a fix. Information logged is the Time, Date, Position, Course Made Good (CMG) and Distance Made Good (DMG).

2.22 POSITION OFFSET CALIBRATION

Most position fixers have intrinsic errors which cause the displayed position of the vessel to be incorrect with respect to the background display of the chart. This difference in position is caused either by the sensor itself or the positioning system principle it is based on. The LCD Plotter allows you to compensate for this by allowing a user defined offset to be entered.

To enter this offset, press the MENU key to display the menu catalogue. Next, using the cursor scroll left and right keys, highlight SETUP. Then using the cursor scroll up and down keys, highlight CALIBRATION. Finally, press the cursor scroll right key to select ON.

Using the cursor keys, position the display cursor to your present position. Once this has been established, press the ENTER key to store.

Part 3 - INSTALLATION INFORMATION

CONTENTS

Para		Page
3.1	Installation Information	3-2
3.2	Precautions	3-2
3.3	Panel Mounting	3-2
3.4	Bracket Mounting	3-3
3.5	Electrical Connections	3-3
3.5.1	<i>power</i>	3-4
3.5.2	<i>data in 1</i>	3-4
3.5.3	<i>data in 2</i>	3-4
3.5.4	<i>data out 1</i>	3-4
3.5.5	<i>data out 2</i>	3-4

3.1 INSTALLATION INFORMATION

3.2 Precautions

To avoid electromagnetic interference, it is recommended that the LCD Plotter be installed no less than 0.3 meters from a compass and 1 metre from the GPS.

The LCD Plotter is water resistant, but not water proof. Use the cover when not in use. The rubber cap must always be properly inserted into the socket on the right part of the plotter and be removed only to insert or remove cartridges. In either situation, this process must be performed in a totally dry environment. The rear connectors that are not connected to cables must remain protected by their appropriate caps.

3.3 Panel mounting

The plotter must be fixed to the panel using the 4mm bolts supplied. The length of the bolts should be cut, if necessary, to allow for 5mm thread for the plotter plus the thickness of the panel. A drilling template is supplied to facilitate the location of the panel cut-outs and location holes. The rubber sealing gasket should be placed between the plotter and bulk-head to prevent moisture penetration and reduce the effects of any vibration transmitted through the instrument panel.

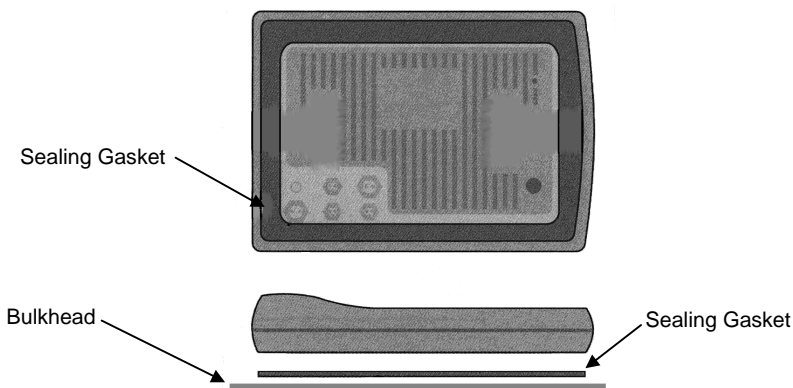

3.4 Bracket Mounting

The LCD Plotter can be installed on the instrument panel using the mounting bracket supplied. The bracket in contact with the plotter should be secured with the screws supplied in the packaging. The “U” shaped section of the bracket should be secured to the panel using 4 flat-head screws, 6mm diameter.

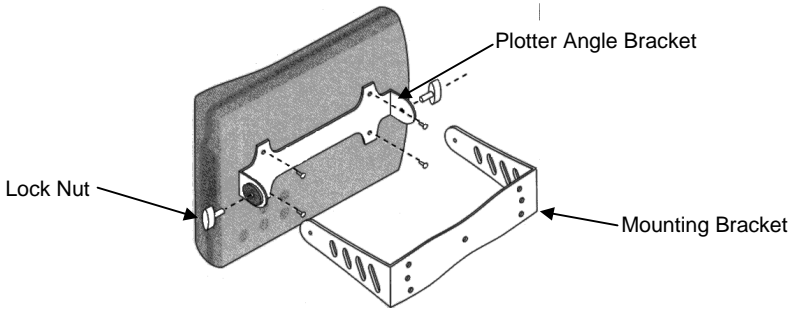

Irrespective of the type of mounting chosen, be sure that the connecting cables on the rear of the plotter are properly tightened to ensure that the connection is water resistant.

3.5 ELECTRICAL CONNECTIONS

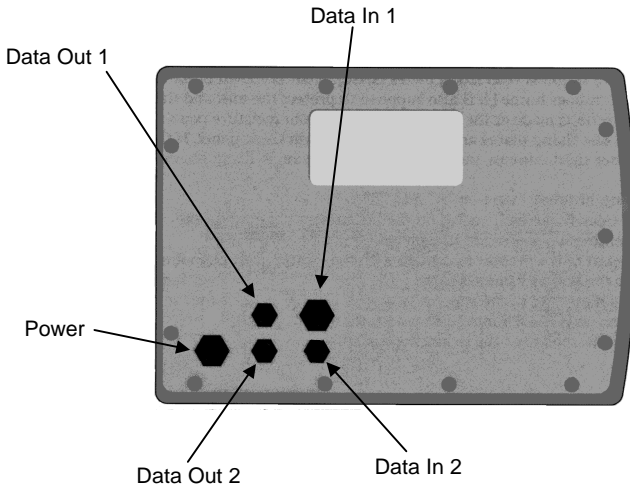

B&G LCD Plotter
Part 3 - Installation Information

3.5.1 Power

External power connection for the LCD Plotter. One cable is supplied as standard.

Cable: N1000212
Red: +12 VDC
Black 0 VDC (GND)

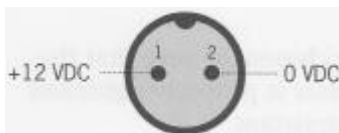

3.5.2 Data In 1

Through this port, the instrument receives data from the GPS and supplies external power (12V, 250mA max.). This supply is switched by the ON/OFF button on the unit and may be used to power GPS antennas. Sentences decoded: DBT, GGA, GLL, GSV, HDM, MTW, MWD, RMA, RMC, VDR, VHWP, VLW, VTG, VWR, VWT, ZDA

Cable: N1000231
Red: VAUX+
Black: VAUX- (GND)
Brown: NMEA INPUT+
Yellow: NMEA INPUT-

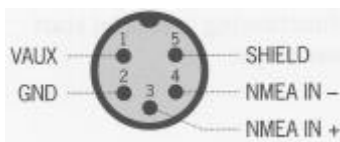

3.5.3 Data In 2

Optional auxiliary NMEA input port for NMEA messages transmitted by the instrument system. Sentences decoded: DBT, GGA, GLL, GSV, HDM, MTW, MWD, RMA, RMC, VDR, VHWP, VLW, VTG, VWR, VWT, ZDA

Cable: N1000221
Violet: NMEA INPUT+
White: NMEA INPUT-



3.5.4 Data Out 1

NMEA output port used for connecting to other NMEA compatible devices. Sentences transmitted: APA, APB, BWC, GGA*, GLL, RMB, RMC*, VTG, XTE, ZDA*

Cable: N1000221
Violet: NMEA INPUT+
White: NMEA INPUT-

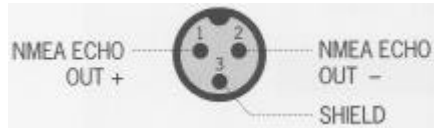

3.5.5 Data Out 2

Optional NMEA output port used for connecting to other NMEA compatible devices. Sentences transmitted: APA, APB, BWC, GGA*, GLL, RMB, RMC*, VTG, XTE, ZDA*

Cable: N1000221
Violet: NMEA INPUT+
White: NMEA INPUT-



Note

Items marked with an * are only available if transmitted by the position fixer and received at Data In 1.

PART 4- DIAGNOSTIC DATA

CONTENTS

Para		Page
4.1	Accessing the Diagnostic Function	4-2
4.2	Demo Mode	4-2
4.3	Input Test	4-2
4.4	Memory Reset	4-2
4.5	Keyboard Test	4-3
4.6	Serial Port Test	4-3
4.7	Checksum Version	4-3

PART 4 - DIAGNOSTIC DATA

4.1 Accessing Diagnostic Data

To access the diagnostic program contained in the LCD Plotter's software (to verify that the instrument is functioning properly) start with the instrument switched off and follow these steps:

- 1 Press and hold any key except OFF.
- 2 Simultaneously press ON.

A menu window will appear. Using the CURSOR key, select the desired operation and press ENTER.

4.2 Demonstration Mode

This requires that a Microchart™ cartridge, containing at least one port plan, to be inserted before turning on the system. The plotter executes zoom operations, automatically, to verify that it is working correctly. Press any key to exit.

4.3 Input Test

This checks the connections between the plotter and the GPS, which must be activated and transmitting messages in compliance with NMEA 0183 standards. If the connections have been made correctly, after a few seconds, a series NMEA strings will appear on the screen indicating that both instruments are functioning correctly. Press CLEAR to exit.

4.4 Memory Reset

This function resets the LCD Chart Plotter to its original factory default settings. The message "WARNING! ! GLOBAL MEMORY RESET. MEMORY CONTENTS WILL BE ERASED" will appear. To confirm press ZOOM+, to abort press ZOOM-.

4.5 Keyboard Test

A graphic stylised layout of keyboard is displayed. Press the keys to verify that they are functioning correctly. Press CLEAR twice to exit.

4.6 Serial Port Test

Verifies the proper functioning of the 2 NMEA input ports and the 2 output ports. To perform this test, make the following connections:

DATA IN # 3 with DATA OUT1 # 1
DATA IN # 4 with DATA OUT1 # 2
DATA IN 2 # 1 with DATA OUT2 # 1
DATA IN 2 # 2 with DATA OUT2 # 2

Without these connections, the test will display the message "Faulty". Press DATA to exit.

4.7 Checksum Version

Displays the current software version installed on the system and checks the integrity of the software itself.

The screen displays the following:

GEOSOFT EPROM CHECKSUM
GEOSOFT REV. followed by the software version number.
BLOCK # 1: partial checksum
BLOCK # 2: partial checksum
TOTAL: total

Press DATA to exit from diagnostic screen.

PART 5 - SPECIFICATION

CONTENTS

Para		Page
5.1	Mechanical Characteristics	5-2
5.2	Electrical Characteristics	5-2
5.3	Memory Characteristics	5-2
5.4	Interface Characteristics	5-3
5.4.1	<i>NMEA input summary</i>	5-3
5.4.2	<i>NMEA output summary</i>	5-3

PART 5 - SPECIFICATION

5.1 Mechanical Characteristics

Maximum clutter:	320 x 230 x 55 mm
Weight:	3 kg
Screen Size:	211.1 x 158.3 mm
Dot size:	0.30 x 0.30 mm
Keyboard:	Silicon Rubber
Front Bezel:	Shock resistant polycarbonate

5.2 Electrical Characteristics

Input Voltage:	12 Volts DC
Consumption:	5 Watts (2 Watts without illumination)
Output Voltage:	12 Volts DC
Protection:	Reverse polarity, over-voltage input protection (up to 25 Volts DC); over-current at the auxiliary voltage output (over 250 mA)
Operating Temperature:	0° C to +55° C
Storage Temperature:	-20° C to +60° C
Display:	Transflexive Monochromatic LCD
Illumination:	Adjustable Cold Cathode
Contrast:	Adjustable Contrast
Keyboard:	Illuminated
Pixel Resolution:	640 x 480
Processing:	CPU V25, 128K SRAM, 4 Mbit EPROM, 256K video RAM, 16-bit graphics processor

5.3 Memory Characteristics

- 10 Memory Pages
- Up to 7,000 track-points (700 x 10 pages)
- Up to 900 markers (90 per page)
- Up to 400 waypoints (40 x 10 pages)
- Up to 10 independent routes comprising 40 waypoints per route
- 5 full screen pages detailing the following:-
 - (i) Status Page
 - (ii) Water Depth
 - (iii) Boat Speed
 - (iv) True or Apparent Wind Angle
 - (v) Time, Lat/Lon, CMG, and DMG

5.4 INTERFACE CHARACTERISTICS

5.4.1 NMEA Input Summary

DBT	Depth Below Transducer
GGA	Global Positioning
GLL	Geographic Position - Latitude/Longitude
GSV	GNSS Satellites in View
HDM	Heading, Magnetic
MTW	Water Temperature
MWD	Wind Direction and Speed
RMA	Recommended Minimum Specific Loran-C Data
RMC	Recommended Minimum Specific Transit/GPS Data
VDR	Set and Drift
VHW	Water Speed and Heading
VLW	Distance Travelled Through the Water
VTG	Course Over Ground and Speed Over Ground
VWR	Apparent Wind Speed and Angle
VWT	True Wind Speed and Angle
ZDA	Time and Date

5.4.2 NMEA Output Summary

APA	Autopilot sentence 'A'
APB	Autopilot sentence 'B'
BWC	Bearing & Distance to Waypoint
GLL	Geographic Position - Latitude/Longitude
RMB	Recommended Minimum Navigation Information
VTG	Course Over Ground and Speed Over Ground
XTE	Cross Track Error, Measured

If the following sentences are received in the NMEA input, they will be re-transmitted on the NMEA output:

GGA	Global Positioning system Fix Data
RMC	Recommended Minimum Specific GPS/Transit Data
ZDA	Time & Date