

# CONTENTS

**GENERAL INTRODUCTION TO B&G NETWORK.....2**

**INTRODUCTION TO NETWORK COMPASS .....3**

**COMPASS DISPLAY UNIT .....4**

**EXAMPLE SYSTEMS USING NETWORK COMPASS.....4**

**INITIAL POWER-UP .....5**

**SETTING THE DISPLAY BACK LIGHTING .....6**

**THE OFF COURSE DISPLAY .....7**

**SETTING THE COURSE MEMORIES .....8**

**THE XTE DISPLAY .....9**

**THE RUDDER DISPLAY .....10**

**THE HEAD/LIFT DISPLAY .....11**

**USING THE TIMER .....12**

**SETTING THE TIMER .....13**

**ENABLING/DISABLING THE TIMER BEEPS .....13**

**ENABLING THE OFF COURSE ALARM.....14**

**SETTING THE COMPASS DAMPING .....14**

**SETTING THE COMPASS OFFSET .....15**

**SETTING THE VARIATION .....15**

**SETTING THE DISPLAY FOR TRUE OR MAGNETIC READINGS .....16**

**ENABLING THE HEAD/LIFT MODE.....16**

**SELECTING THE DISPLAY MODE .....17**

**CALIBRATING THE COMPASS .....17**

**OPERATION WITH AUTOPILOTS .....18**

**TROUBLESHOOTING .....19**

**INSTALLATION .....20**

**SITING THE FLUXGATE .....21**

**INSTALLATION DATA.....22**

**SPECIFICATIONS.....23**

## **GENERAL INTRODUCTION TO B&G NETWORK**

Welcome to the B&G Network system. This World beating series of intelligent navigational instruments has been brought to you through a combination of scientific innovation and high quality production to create a computerised data system you can trust. As an intelligent system each unit can be used by itself to display specific data, alternatively any combination of units can be linked into a Network with units processing their own data or acting as repeaters for data from other units. This Network provides a comprehensive navigational system. Screened cables combined with the latest technology provide protection from interference between units and other systems.

The Network system is continuously expanding your options and currently consists of the following units:

### **INSTRUMENTS**

- Network SPEED
- Network DEPTH
- Network QUAD
- Network WIND
- Network TACK
- Network DATA
- Network COMPASS

### **NAVIGATIONAL AIDS**

- Network NAV
- Network GPS
- LCD CHART

### **AUTOPILOTS**

- Network PILOT

## INTRODUCTION TO NETWORK COMPASS

The Network COMPASS unit uses the latest advances in electronics and magnetic fluxgate technology to display a true or magnetic heading, as well as Off Course, Cross Track Error (XTE)\*, Rudder Angle\* and Head/Lift information on an easy to read Liquid Crystal Display (LCD). Five keys on the unit select the displayed data, calibration factors and alarms.

It can operate as a standalone compass display or as part of an Integrated B&G Network Instrument System. The unit can also operate as a repeater of course data received via the Network. These connections plug directly into the rear of the display.

The Network COMPASS includes two adjustable alarms:

- Off course alarm
- Head alarm

An internal alarm buzzer will sound and the display will flash **-A-** when the alarm condition is met. Other Network instruments will also sound their alarms and flash their displays, and the alarm condition can be cleared by pressing any key on any Network instrument.

Additionally a racing timer with alarm signals at set intervals is included in the unit.

\* These functions will only appear if the relevant sensors (for example, GPS<sup>plus</sup> or Network PILOT) are in the system.

## COMPASS DISPLAY UNIT

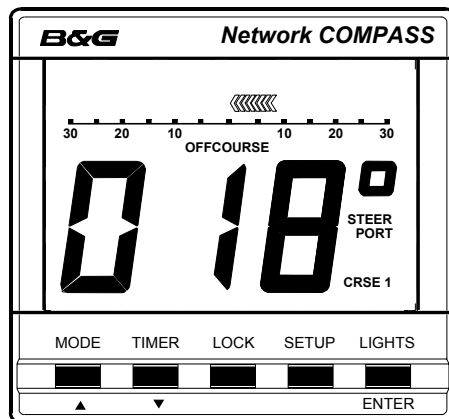

## EXAMPLE SYSTEMS USING NETWORK COMPASS

Up to four COMPASS units can be connected to the system. Only one of these should be linked to a fluxgate and set to transducer mode, the others must be set to repeater mode. Refer to SELECTING THE DISPLAY MODE to see how to change modes.

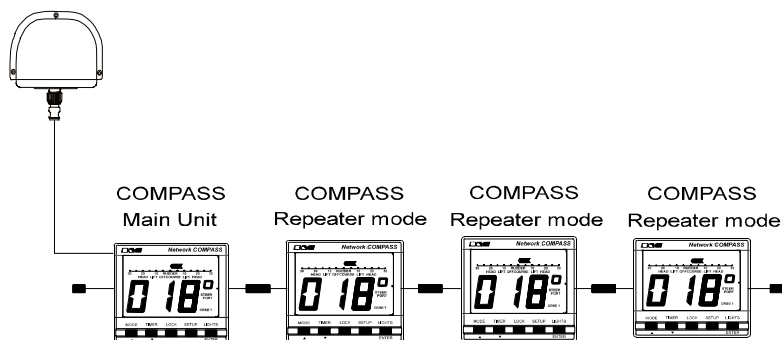

In this configuration the main unit controls all the measurement parameters such as offset and damping. These parameters can be changed via the keyboard on any of the units: repeaters will send appropriate network messages to the main unit so that it can keep its parameters up to date.

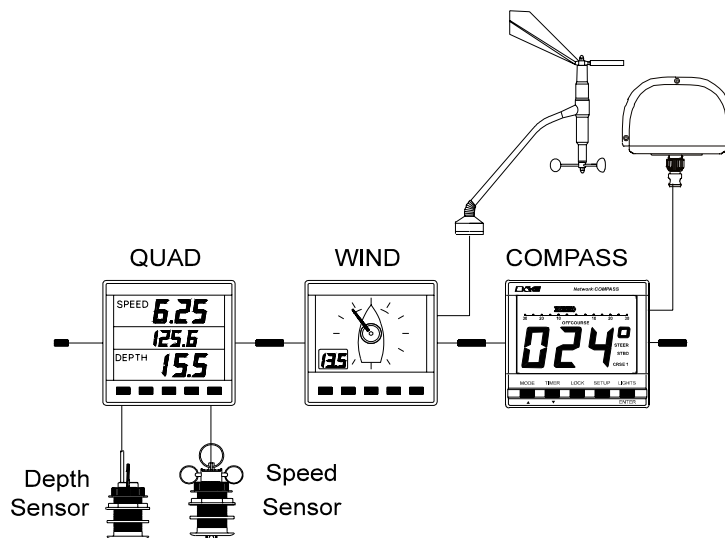

In this configuration the COMPASS unit is set to transducer mode and will send heading data to the other instruments. The other Network units are also transmitting data that the COMPASS may be able to use. For example, if the COMPASS is set to Head/Lift mode the wind angle data will cause it to switch between port and starboard tacks automatically.

## INITIAL POWER-UP

When a COMPASS unit is powered up for the first time it will automatically adjust itself to the phase characteristics of the fluxgate sensor, so if it is to be used with a fluxgate (that is, in transducer mode) the fluxgate should be installed and connected before applying power. Refer to the installation guidelines at the back of this manual for advice on optimum siting of the fluxgate. During the phase adjustment the display will show **PHS** and a pair of chevrons to indicate which of the phase settings is currently being tested.

When all the phase settings have been tested the optimum one is selected and stored for future use. The complete phase adjustment procedure takes about 20 seconds.

The same phase adjustment is also carried out immediately before a calibration swing (see CALIBRATING THE COMPASS, page 17).

## SETTING THE DISPLAY BACK LIGHTING

The Network COMPASS display back light has three brightness settings or off. Pressing the **LIGHTS** key cycles through these in the following order:

- **L 0** OFF
- **L 3** High
- **L 2** Medium
- **L 1** Low

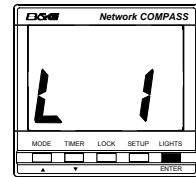
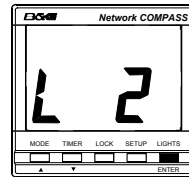
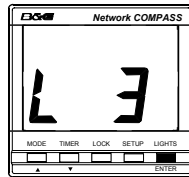
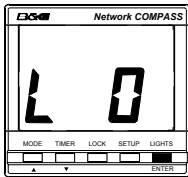

## THE OFF COURSE DISPLAY

Pressing the **MODE** key will cycle the display between Off Course, Cross Track Error (XTE) if a Network GPS<sup>plus</sup> is fitted, Rudder angle if a Network PILOT is fitted and the Head/Lift display (if enabled).

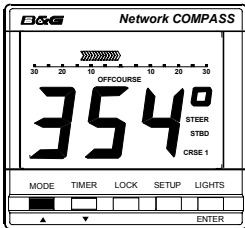

The Off Course display

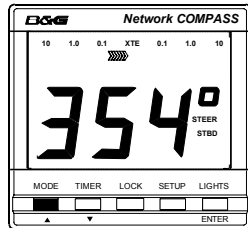

The XTE display with GPSplus

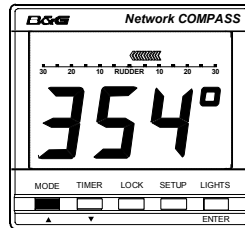

The Rudder display with Network Pilot

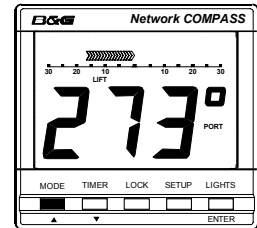

The Head/Lift display if enabled

The unit will autodetect the presence of a GPS or PILOT on the Network and will activate the displays accordingly. The Off Course display is used to show the difference between the current heading and the heading stored in the selected course memory (see **SETTING THE COURSE MEMORIES**).

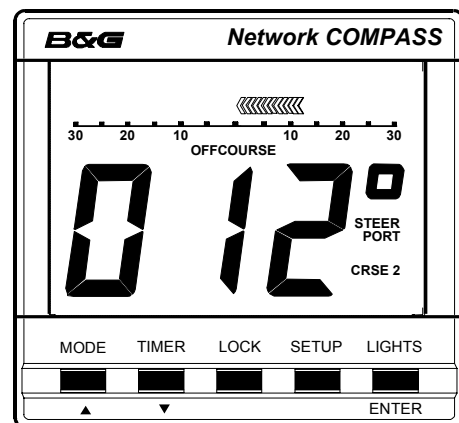
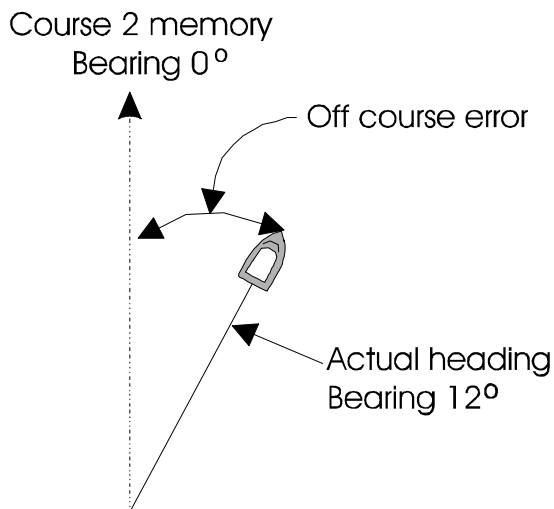

In this instance the vessel is heading starboard of the setting in the course 2 memory and the display shows the current bearing. The Off Course scale is visible below the bar graph which points to port, and the legends **STEER** and **PORT** indicate the direction in which to steer to correct the error.

The Off Course scale indicates how many degrees the vessel is from its intended heading.

## SETTING THE COURSE MEMORIES

Whilst in Off Course mode the two course memories may be set. The currently active course memory is shown by the legend **CRSE1** or **CRSE2**.

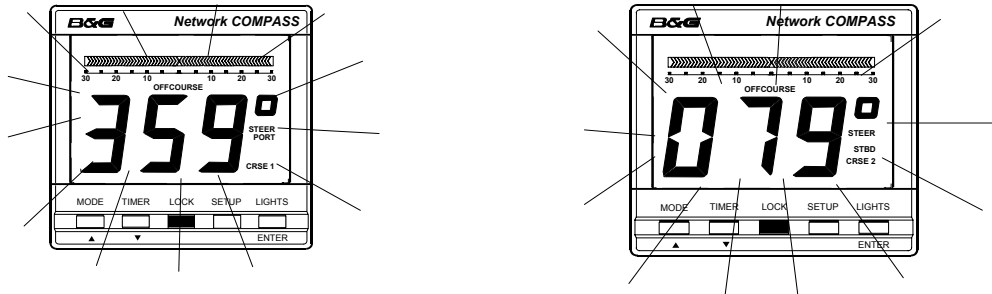

Pressing the **LOCK** key brings up the current course memory (e.g. **CRSE1**) which will flash on the display. Pressing **LOCK** twice displays the other course memory (**CRSE2**). Whilst the setting is displayed it can be adjusted by using the **▲** and **▼** keys (normally the **MODE** and **TIMER** keys). The display will revert to normal operation five seconds after the last key is pressed.

Alternatively the displayed course memory can be reset by sailing on a heading then depressing the **LOCK** key for two seconds. The current course will then be stored in the selected course memory.

In Head/Lift mode the same methods can be used to set the **PORT** and **STBD** heading memories (see THE HEAD/LIFT DISPLAY).

If a remote button, shown below, is fitted as an option then this performs the same functions as the **LOCK** key.

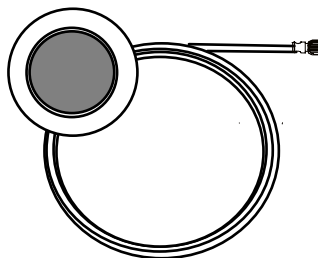

The Optional Remote Button with 15m cable



## THE XTE DISPLAY

REQUIRES A GPS<sup>plus</sup> ON THE NETWORK. The Cross Track Error display is used to indicate how far the vessel is from the intended track (from waypoint to waypoint).

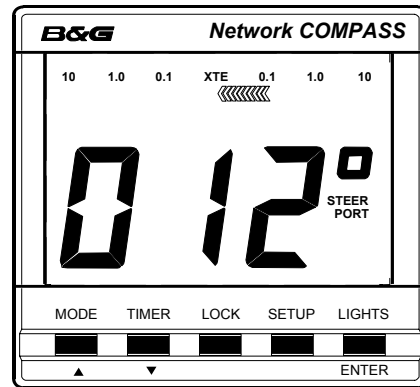
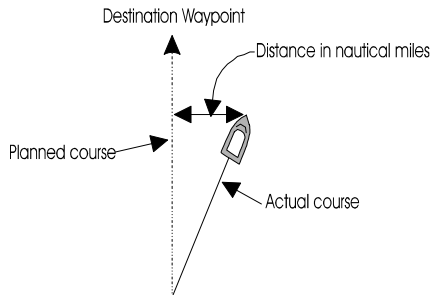

In this instance the vessel is heading starboard of the planned course. The display shows the current bearing and the **XTE** scale is visible above the bar graph which points to port. The legends **STEER** and **PORT** indicate the direction in which to steer to correct the error.

The **XTE** scale indicates how many nautical miles the vessel is from the track (waypoint to waypoint).

## THE RUDDER DISPLAY

REQUIRES B&G NETWORK PILOT IN CIRCUIT. The rudder display indicates the current angle of the rudder, which is particularly useful on wheel steered boats.

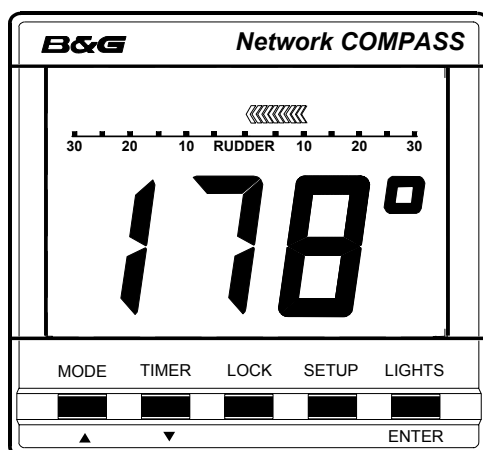
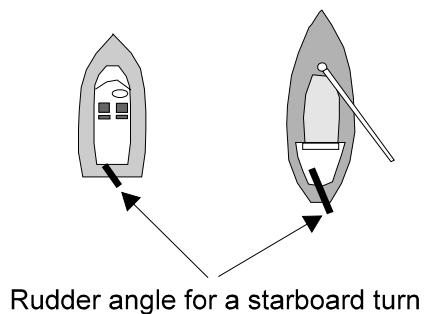

The vessel is turning to starboard, the display shows the current heading and the rudder scale is visible beneath the bar graph which points to port, the direction to turn the wheel to straighten the rudder.

The scale indicates the rudder angle in degrees.

## THE HEAD/LIFT DISPLAY

THE HEAD/LIFT PAGE HAS TO BE ENABLED IN THE SETUP MENU before it can be displayed.

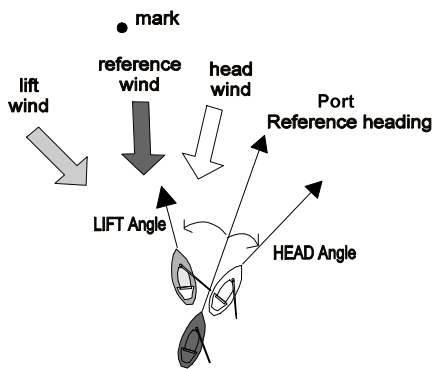
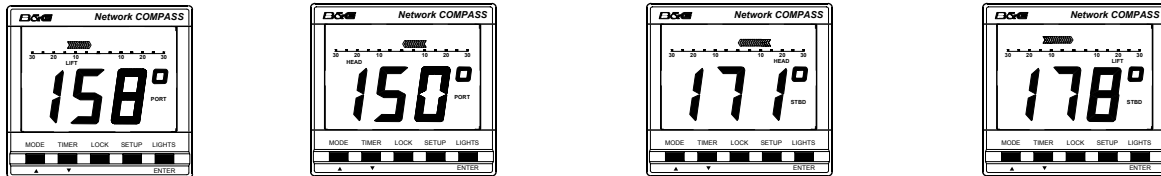

A LIFT and a HEAD on the port tack

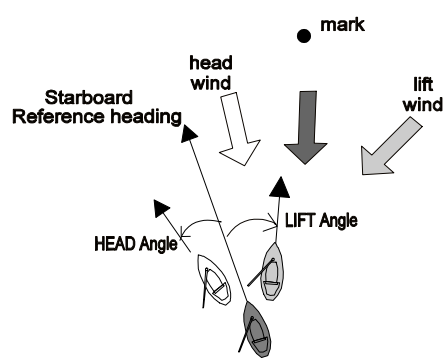

A LIFT and a HEAD on the starboard tack

The port and starboard tacks are stored manually as **PORT** and **STBD** headings (see SETTING THE COURSE MEMORIES). When the helmsman has to vary from these headings due to wind changes the legends **HEAD** or **LIFT** will appear on the display for the relevant tack. If wind data is available over the Network a tack will automatically change between the **PORT** and **STBD** reference course. Otherwise it can be switched manually by two short presses of the **LOCK** key or the remote button. The **HEAD/LIFT** values are displayed in the analogue bar graph as degrees. If the Off Course alarm is enabled the unit will sound an alarm and flash **-A-** if a head occurs. Press any key on the unit to cancel the alarm. The alarm will not sound for a lift.

## USING THE TIMER

Pressing the **TIMER** key enters the timer display mode, which is shown by the presence of a flashing colon.

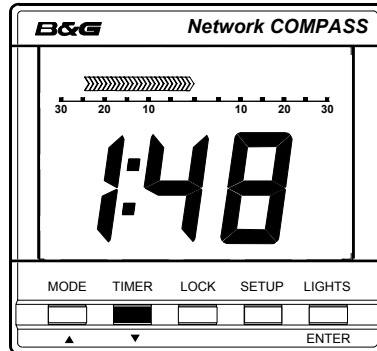

The timer can be set to any required value to a maximum time period of 99 hours 59 minutes. The analogue bar graph shows the time left, in minutes, from 30 minutes before time zero (bar graph on the left) to 30 minutes after (bar graph on the right).

The unit will also beep to indicate the passage of set units of time, the number and frequency of beeps depending on the time left to time zero. There are no beeps after time zero. The beep sequences are shown in the table below:

Beeps begin at	Beeps end at	Number of beeps	Frequency
< 60 hours	1 hour	5	every hour
< 1 hour	=>10 minutes	4	every 10 minutes
< 10 minutes	=> 1 minute	3	every minute
< 1 minute	=> 10 seconds	2	every 10 seconds
< 10 seconds	>0	1	every second
= 0	>-10 seconds	continuous	for 10 seconds

This means that for the example given above of 1 hour 48 minutes the following beeps will occur:

- 5 beeps at 1:00
- 4 beeps at 0:50; 0:40; 0:30; 0:20; 0:10
- 3 beeps at 0:09; 0:08; 0:07; 0:06...0:01
- 2 beeps at 0:00:50; 0:00:40...0:00:10
- 1 beep at 0:00:09; 0:00:08; 0:00:07...0:00:01
- continuous beep at 0:00:00 for ten seconds

At each of these periods the display will briefly show the time left. Press **MODE** to return to the heading display.

## SETTING THE TIMER

1. Press **TIMER** to enter timer mode.
2. Press **SETUP** to give the display **h:xx** (**xx** represents a two digit number) the **h** will be flashing.
3. Press **ENTER** and the numbers will flash.
4. Alter the hours using the **▲** or **▼** keys. If the key is held down the numbers will change more quickly.

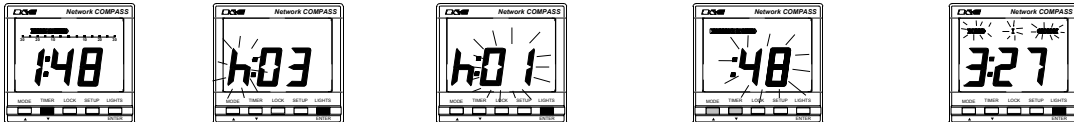

5. Press **ENTER** to adjust the count down minutes. The display will show the current minutes setting and the bar graph on the left will represent the minutes before time zero (up to 30 minutes).
6. Alter the minutes using the **▲** or **▼** keys.
7. Press **ENTER** to set the timer, with the seconds set to zero. Both sides of the bar graph will now be full to show that the timer is ready to be started.
8. Press **ENTER** to start the timer and exit to the timer display.

## ENABLING/DISABLING THE TIMER BEEPS

1. Press **TIMER** to enter timer mode.
2. Press **SETUP** to give the display **h:xx** (**xx** represents a two digit number) the **h** will be flashing.
3. Press **SETUP** to give the **O:FF** or **:on** display (colon flashing).
4. Press **ENTER**. The **O:FF** or **:on** will flash.

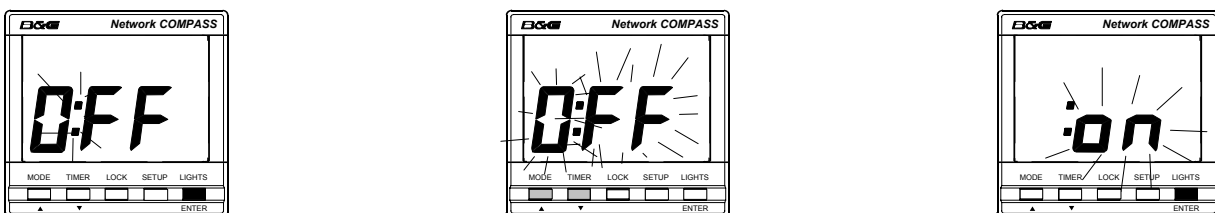

5. Press **▲** or **▼** keys to select **:on** or **O:FF**, enabling or disabling the beeps.
6. Press **ENTER** to store the new setting.
7. Press **SETUP** to return the unit to the timer setup display.
8. Press **MODE** or **TIMER** to return to the desired mode.

## ENABLING THE OFF COURSE ALARM

Ensure that the instrument is not in Timer mode.

1. Press **SETUP** until the **OFFCOURSE** legend flashes to indicate the alarm set up display. This value is preset to 0° which is shown as **OFF**.
2. Press **ENTER** then **OFF** will flash.
3. Press the **▲** or **▼** keys to set the desired value (between 0° and 30°).
4. Press **ENTER** to accept value and return to setup mode.
5. Press **MODE** to return to desired mode.

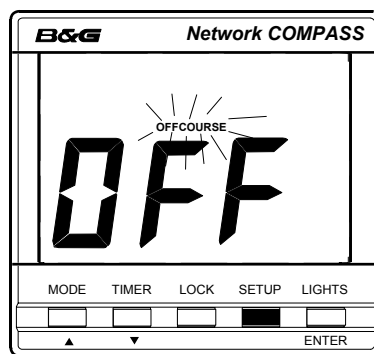

## SETTING THE COMPASS DAMPING

Compass damping is used to smooth out compass readings. Ensure that the instrument is not in Timer mode.

1. Press **SETUP** until **dx** is displayed. The **d** will flash.
2. Press **ENTER**, the numbers will flash.
3. Press the **▲** or **▼** keys until the desired value is shown (between 1 and 99 seconds).
4. Press **ENTER** to accept value and return to setup mode.
5. Press **MODE** to return to desired mode.

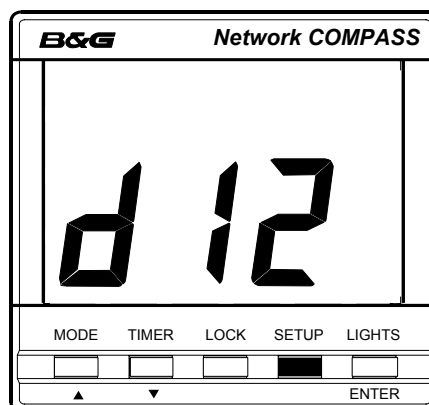

## SETTING THE COMPASS OFFSET

The compass offset compensates for fixed errors in the compass after installation and calibration. For example, the sensor orientation may not be exactly correct.

1. Press **SETUP** until a bearing is displayed and the degrees sign is flashing.
2. Press **ENTER**. The numbers will flash.
3. Press the **▲** or **▼** keys until the desired value is shown (between  $+180^\circ$  and  $-180^\circ$ ). A positive offset has a bar graph on the right of the display, a negative offset has a bar graph on the left of the display
4. Press **ENTER** to accept the value and return to setup mode.
5. Press **MODE** to return to the desired mode.

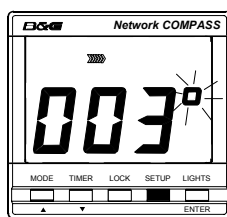

Compass Offset at  $-3^\circ$

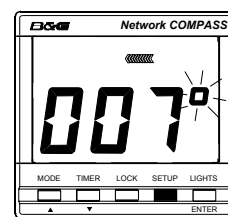

Compass Offset at  $+7^\circ$

## SETTING THE VARIATION

1. Press **SETUP** until **Uxx** is displayed (xx represents a number) and the U is flashing.
2. Press **ENTER**. The numbers will flash.
3. Press the **▲** or **▼** keys until the desired value is shown (between 90W and 90E). An easterly variation has a bar graph on the right of the display, a westerly variation has a bar graph on the left of the display.
4. Press **ENTER** to accept the value and return to setup mode.
5. Press **MODE** to return to the desired mode.

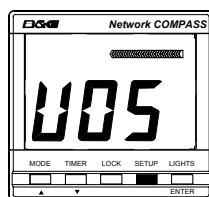

Variation is  $5^\circ\text{E}$

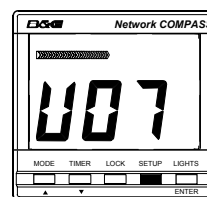

Variation is  $7^\circ\text{W}$

## SETTING THE DISPLAY FOR TRUE OR MAGNETIC READINGS

1. Press **SETUP** until **TRUE** is flashing and either **ON** or **OFF** is displayed.
2. Press **ENTER**. **ON** or **OFF** will flash.
3. Press the **▲** or **▼** keys to switch the setting between **ON** and **OFF**
4. Press **ENTER** to accept the setting and return to setup mode.
5. Press **MODE** to return to the desired mode.

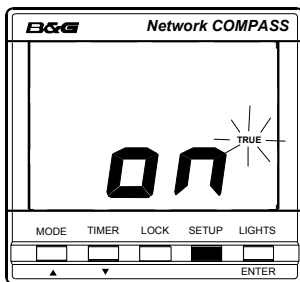

Compass will display TRUE headings

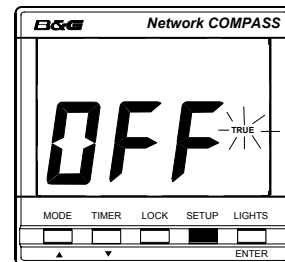

Compass will display MAGNETIC headings

## ENABLING THE HEAD/LIFT MODE

1. Press **SETUP** until **HEAD/LIFT** is flashing and either **ON** or **OFF** is displayed.
2. Press **ENTER**. **ON** or **OFF** will flash.
3. Press the **▲** or **▼** keys to switch the setting between **ON** and **OFF**.
4. Press **ENTER** to accept the setting and return to setup mode.
5. Press **MODE** to return to the desired mode.

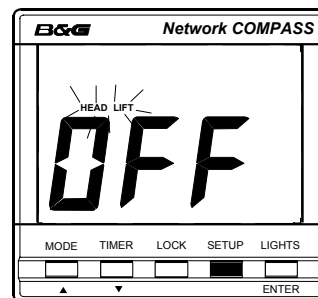
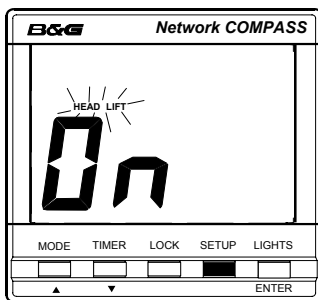



## SELECTING THE DISPLAY MODE

1. Press **SETUP** until a flashing **t** and either **r** or **t** is displayed.
2. Press **ENTER**. **r** or **t** will flash.
3. Press the **▲** or **▼** keys to switch the setting between repeater (**r**) and transducer (**t**).
4. Press **ENTER** to accept the setting and return to setup mode.
5. Press **MODE** to return to the desired mode.

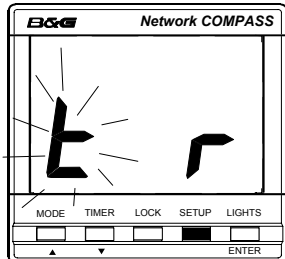

Unit set to repeater mode

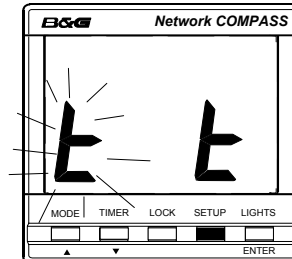

Unit set to transducer mode

## CALIBRATING THE COMPASS

Remember that a compass offset may be entered if the heading shows a fixed error (see section **SETTING THE COMPASS OFFSET**). The purpose of a calibration swing as described in this section is to measure the deviation pattern of the compass at a large number of points so that a more detailed correction can be made.

1. Press **SETUP** until the rotating segment is displayed.
2. Press **ENTER** to begin a calibration swing. This starts with a re-phasing of the fluxgate signals which takes about 20 seconds (see **INITIAL POWER-UP**). The display shows **PHS** and a pair of chevrons which move as successive phases are tested. When the re-phasing has been completed the display shows a degree count, starting at zero.
3. Sail the vessel through a full circle. The display will count up to 360. During the turn the bar graph shows the rate of turn in relation to the optimum rate of 4.5° per second: chevrons on the left mean the turn rate is slower, chevrons on the right mean it is faster. Slow turn rates are not a problem, but an excessively fast turn rate (say, greater than 9° per second) may result in a failed calibration.

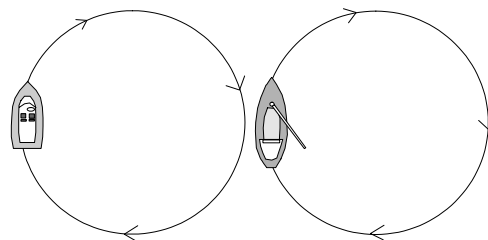
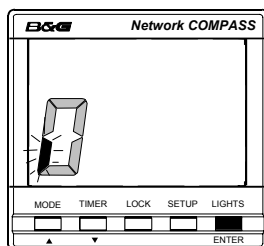

When the display shows a clockwise rotating segment press **ENTER** and turn the boat through a full circle

4. On completion the compass will automatically calculate and store its deviation parameters and then display a **-P-** for pass or an **-F-** for fail (see **TROUBLESHOOTING**).
5. Press **ENTER** to accept the calibration. The rotating segment will reappear.
6. Press **MODE** to return to desired mode.

## OPERATION WITH AUTOPILOTS

REQUIRES A B&G NETWORK AUTOPILOT IN SYSTEM. If the unit is set up within a system that includes a Network ACP1 or ACP2 autopilot and a Network Pilot Display unit there are two options for the Network configuration:

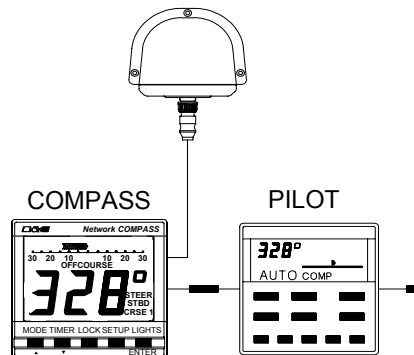

- The COMPASS unit can display rudder and compass information generated by the PILOT.
- The fluxgate sensor can be connected to the COMPASS unit giving an alternate remote fluxgate option.

The Network is more efficient if the fluxgate is connected to the Network ACP Pilot and the COMPASS is used as a data repeater. However, the system will operate normally with the Pilot accepting data from the COMPASS unit.

Only one fluxgate is required per Network system. If a backup fluxgate is connected to the COMPASS, it will override the PILOT's fluxgate if the COMPASS unit is set to transducer mode. The PILOT will then act as a repeater for the COMPASS data. When the backup fluxgate is not in use it is important that the COMPASS is specifically set up in repeater mode. The fluxgate on the Network COMPASS may be enabled by changing modes in the event of a PILOT fluxgate failure.

PILOT Off Course data is not fed into the COMPASS unit through the Network. If this information is required the PILOT heading can be manually entered into one of the COMPASS course memories.

## TROUBLESHOOTING

PROBLEM	POSSIBLE CAUSE
Display fails to light up	Power not connected. Supply not 10 to 16 Volts.
Data is not repeated from Network	Compass not in repeater mode. Cables not correctly fitted.
Compass fails to calibrate (-F-)	Calibration manoeuvre performed badly. Compass installed too close to onboard metallic object. Calibration manoeuvre attempted near to large metallic vessel or equipment, e.g. loading crane.
Display shows a number and the alarm buzzer sounds	Error message. Switch off and restart. (If the message persists after three restart attempts contact your authorised dealer for assistance.)
-C- error message	Compass fluxgate error. Switch off check wiring. Check that fluxgate is not too close to a metallic object. (If the message persists after three restart attempts contact your authorised dealer for assistance.)

## INSTALLATION

The display heads are supplied with a clip-in mounting bracket which allows for easy installation. Access from behind is not necessary to secure the unit in place. However, to prevent theft and permanently fix the unit in position, locking studs and thumb nuts are supplied.

### SITING THE DISPLAY UNIT

All Network Instruments are designed for mounting on or below deck. A mounting position should be selected where they are:

- Easy to read by the helmsman
- On a smooth and flat surface
- At least 100mm (4") from a compass
- Accessible from behind for fitting locking studs if required

### MOUNTING THE DISPLAY UNIT

Use the cutting template supplied to mark the centres of the holes for the self-tapping screws, the fixing stud holes, and the mounting bracket.

- The template allows 4mm (5/32") between adjacent units for the suncover, increase this distance if required to maximum of 60mm (2 3/8") between units or 180mm (3 1/8") between centres. For greater distances between units extension cables are available.
- Use a 70mm (2 3/4") diameter hole-cutter for the mounting bracket hole.
- Use a 2.9mm drill for the self-tapping screw holes. Use a 5mm (3/32") drill for the locking stud holes.
- Secure the mounting bracket to the bulkhead with the self-tapping screws supplied.
- Fit the rubber sealing gasket around the mounting bracket.
- Screw the locking studs into the back of the display head (if required).
- Carefully pass the cable tails through the mounting bracket hole and connect the cables to the main units.
- Clip the display head into the mounting bracket.
- Secure the instrument with the thumb nuts supplied.

## SITING THE FLUXGATE

Mount the unit upright on a flat vertical bulkhead where it will be:

- A safe distance from external magnetic interference: 1m/3ft from VHF, RDF, loudspeakers, depth sounders, engines, or power cables carrying heavy current
- 3m/10ft from Radar and SSB equipment
- Externally mounted on steel hulled vessels
- Well protected from physical damage
- With the connector downwards

## MOUNTING THE FLUXGATE

- Secure the unit in the selected site using the self tapping screws provided
- Route the cable to the Network COMPASS display unit avoiding other cables carrying heavy currents (for example, engine starter or trim tabs)
- Secure in place using cable clips or tie-wraps
- Avoid bending the cable through a tight radius especially near the connector as this may damage the wires inside the cable

**INSTALLATION DATA**

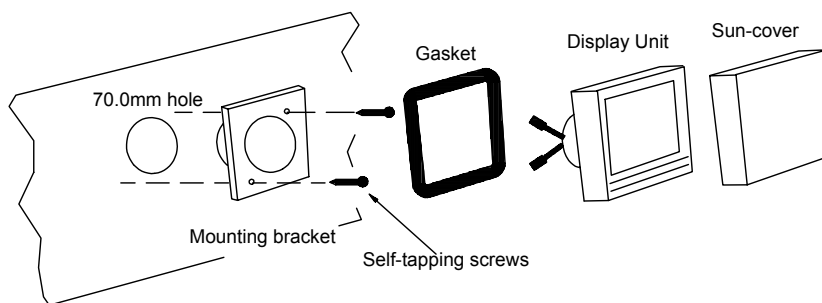
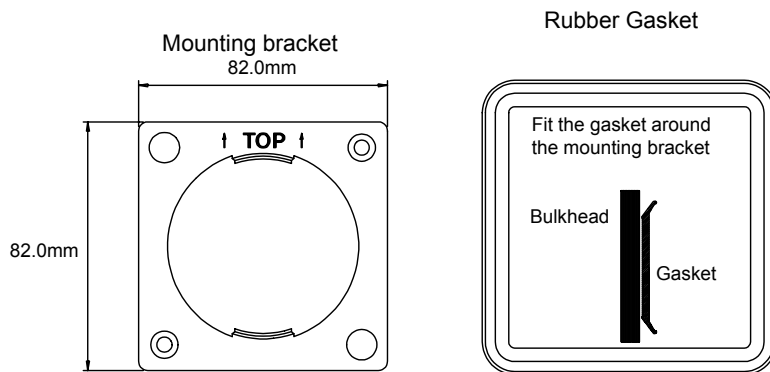
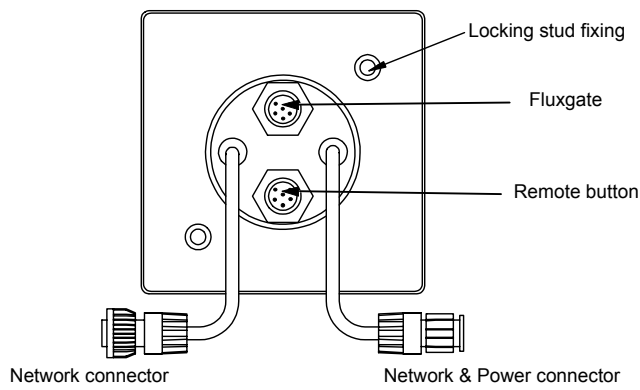
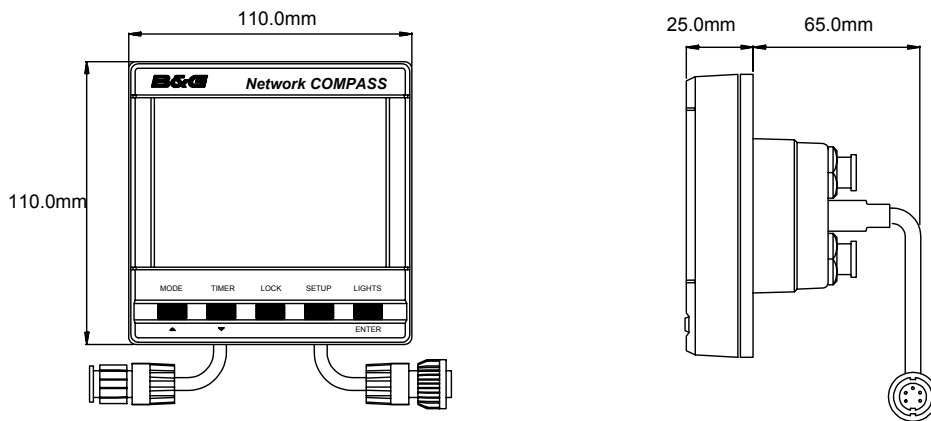

## SPECIFICATIONS

### PHYSICAL PARAMETERS

<b>Display</b>	Backlit Liquid Crystal Display
<b>Dimensions</b>	110 x 110 x 26 mm; 4.25 x 4.25 x 1" A space of 65 mm (2.6") is required behind the bulkhead for the display barrel.

### ENVIRONMENTAL

<b>Operating Temp</b>	-10 to +55 °C, +14 to +131°F @ 93% RH
<b>Storage Temp</b>	-25 to +70 °C, -13 to +158 °F @ 95% RH
<b>Sealing</b>	Fully sealed front, suitable for bulkhead cockpit mounting.

### ELECTRICAL

<b>Power Supply</b>	12V DC nominal (10V to 16V).
<b>Operating Current</b>	40 mA to 100 mA
<b>Protection</b>	Connect via external fuse or circuit breaker

### CABLES AND CONNECTIONS

Connection to adjacent units and other equipment is via plug and socket connections which carry power and Network data between units.

### ALARM

Internal piezo buzzer.

### ELECTROMAGNETIC COMPATIBILITY

This product complies with the requirements of European standard EN60945 relating to electromagnetic compatibility. The product should not be modified in any way, as this could lead to non-compliance of the product with the relevant European Directives.