

CONTENTS

| | |
|---|----|
| CONTENTS..... | 1 |
| GENERAL INTRODUCTION TO B&G NETWORK | 2 |
| INTRODUCTION TO NETWORK DATA..... | 3 |
| EXAMPLE SYSTEMS USING NETWORK DATA..... | 4 |
| ALARMS AND THE NETWORK DATA UNIT | 5 |
| USING THE SPEED KEY | 6 |
| USING THE DEPTH KEY | 7 |
| USING THE WIND KEY..... | 8 |
| USING THE OPTIONS KEY | 9 |
| USING THE LIGHTS KEY | 10 |

| | |
|--------------------------------|-------|
| NETWORK ALARMS..... | 11 |
| FAULT AND ERROR MESSAGES | 12 |
| INSTALLATION | 13,14 |
| SITING THE UNIT | 13 |
| MOUNTING THE UNIT..... | 13 |
| SPECIFICATION | 15 |
| CONDITIONS OF WARRANTY | |

GENERAL INTRODUCTION TO B&G NETWORK

The B&G Network range of instruments is designed to be used as individual units or connected together to form an integrated navigational system. A single network cable is used to carry data and power between units. The latest technology and screened cables throughout the Network System ensure the ultimate protection from interference between units and other systems. All Network instruments can be linked to Network PILOT, Network CHART, Network GPS or Network LORAN receivers or via NMEA 0183 (v1.5) to other navigational equipment.

INSTRUMENTS

Network SPEED
Network DEPTH
Network QUAD
Network WIND
Network TACK
Network DATA

NAVIGATIONAL AIDS

Network GPS
Network LORAN
Network NAV
Network CHART

AUTOPILOTS

Network PILOT

COMMUNICATIONS

Network VHF

INTRODUCTION TO NETWORK DATA

The Network DATA unit is a repeater of available networked information supplied from other Network Instruments via the system network. The information is presented on a large back-lit Liquid Crystal Display (LCD).

It has no sensor interfaces as all data is passed to the unit via the system network cables. The unit is capable of transmitting NMEA 0183 v1.5 data via the network cables. The Network DATA unit has its' own internal buzzer that sounds when an alarm condition is met and received via the system network from other Network units. The row of five keys are used for selecting the displayed information when the appropriate unit and its sensor is connected to the Network DATA unit.

- **SPEED** Current, maximum and average speed
- **DEPTH** Water depth and depth alarms
- **WIND** Apparent wind speed and angle,
True wind speed and angle, VMG.
- **OPTIONS** Heading, DR distance, DR course,
Temperature, Timers, Battery Volts.
- **LIGHTS** Three levels of illumination and off.

NETWORK DATA DISPLAY UNIT

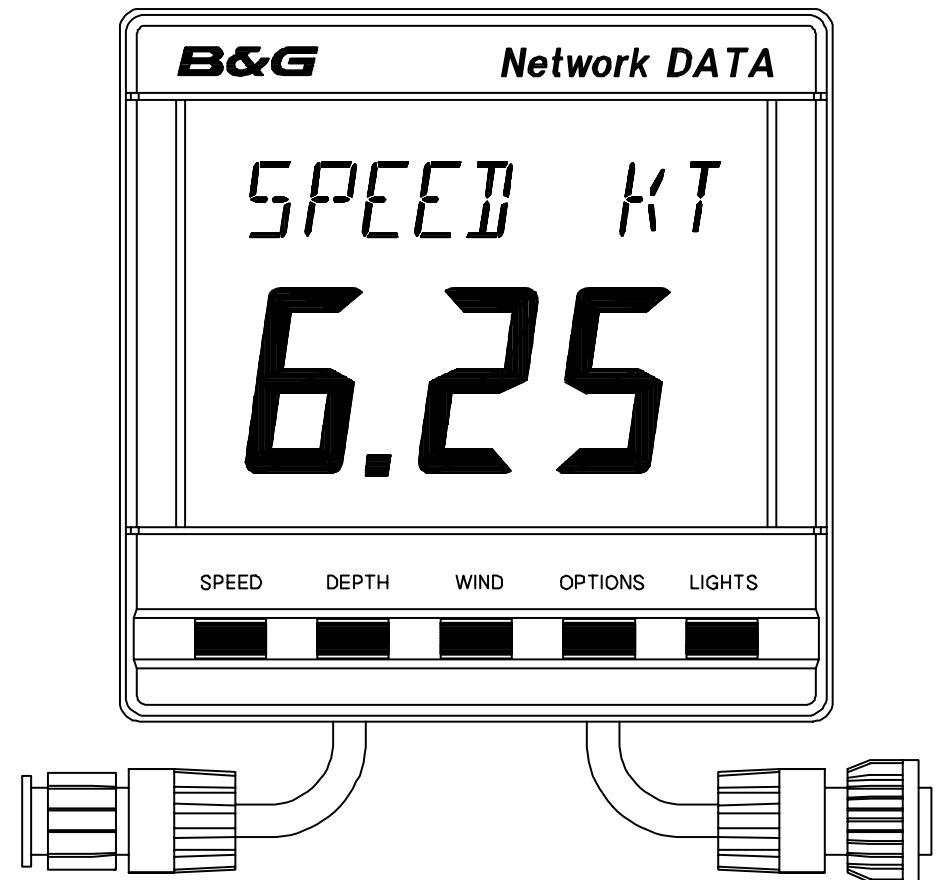

EXAMPLES SYSTEMS USING NETWORK DATA

Network QUAD main unit with DATA unit repeaters for depth and speed functions.

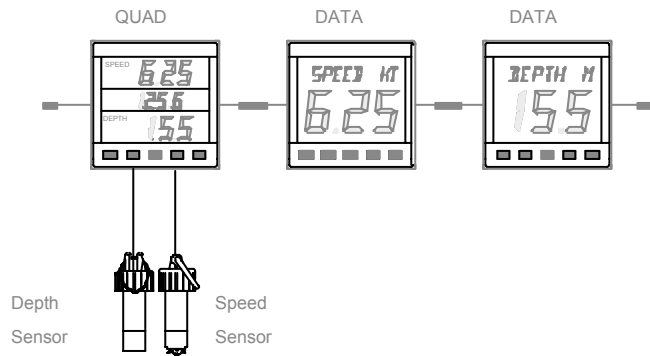

Network SPEED, DEPTH and WIND main units with DATA repeater for all functions.

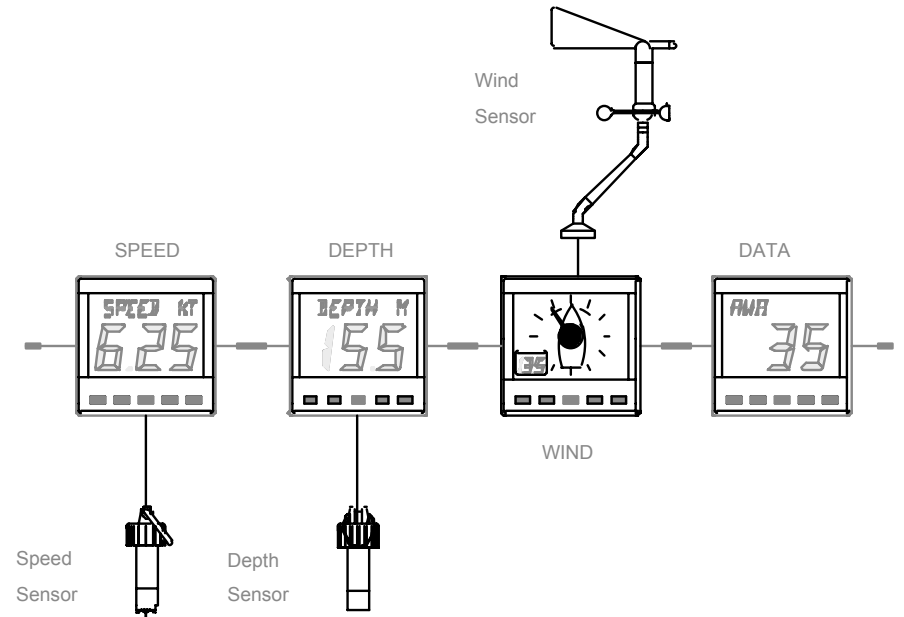

Up to a maximum of four Network DATA units maybe used in an integrated Network Instrument System, where the total number of units does not exceed twenty.

ALARMS AND THE NETWORK DATA UNIT

The Network DATA unit can display the depth alarm information that has been set on either Network DEPTH or Network QUAD units. It is NOT able to change the alarm values or enable/disable them. The Network DATA unit has its' own internal alarm buzzer that will sound when an alarm condition is met and transmitted over the entire Network System. It is silenced by pressing any of the five keys, in the lowest row, of any Network display unit.

The Network DATA unit can display the alarm value that has been set or **OFF** if it is not enabled. The following are examples of a depth alarm displays.

See USING THE DEPTH KEY for all the available alarm displays.

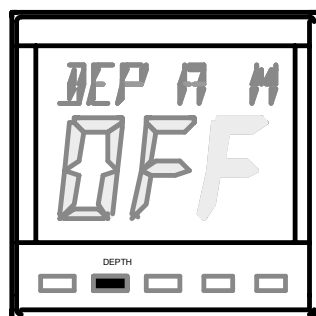
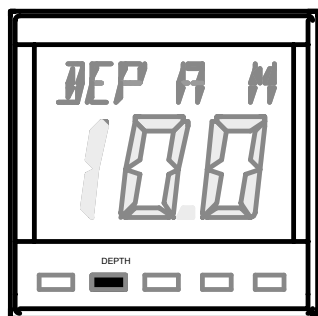

USING THE SPEED KEY

Press the **SPEED** key to cycle through the speed options.

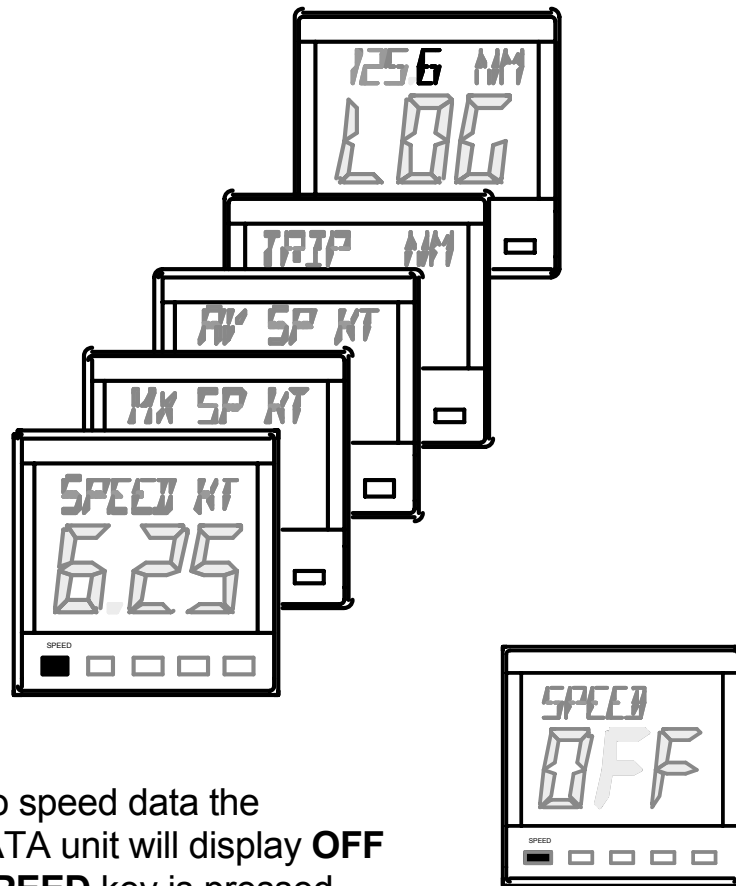

If there is no speed data the Network DATA unit will display **OFF** when the **SPEED** key is pressed.

The speed information is only displayed when the Network DATA unit is connected to a Network QUAD or Network SPEED unit. The units in which the speed and log information is display is set on the main display unit.

When speed data is available the following can be displayed:

- **SPEED KT** Boat speed in Knots **KT** or MPH **MH**.
- **MX SP KT** Maximum boat speed since the last reset of the trip log.
- **AV SP KT** Average boat speed since the last reset of the trip log.
- **TRIP NM** The trip log value in Nautical Miles **NM** or Statute Miles **M**.
- **LOG NM** The stored log in Nautical Miles **NM** or Statute Miles **M**.

USING THE DEPTH KEY

Press the **DEPTH** key to cycle through the depth options.

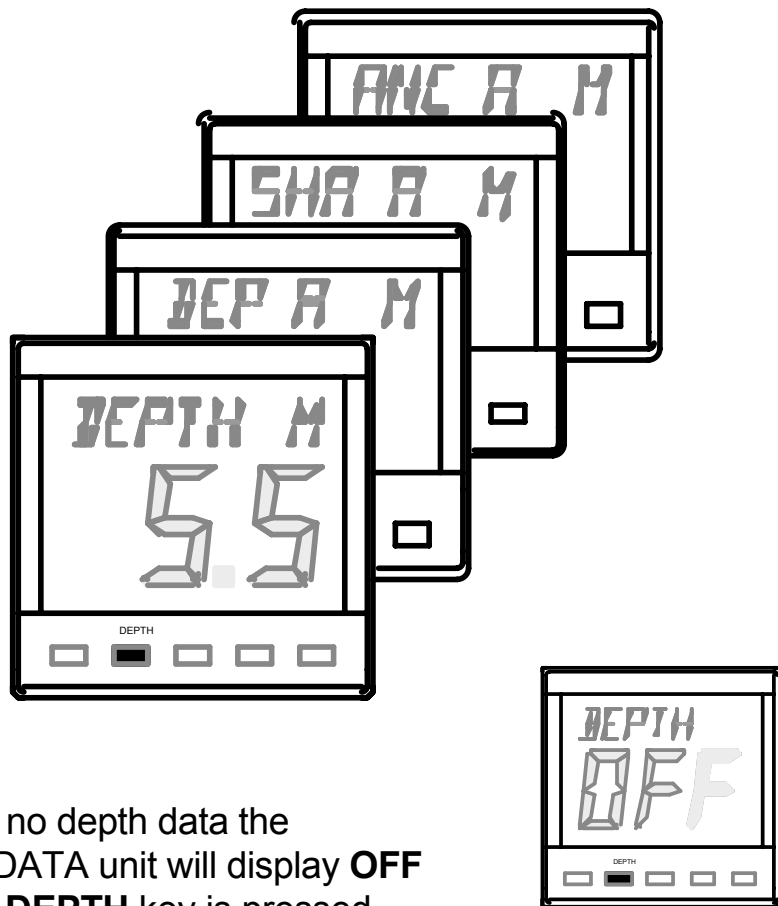

If there is no depth data the Network DATA unit will display **OFF** when the **DEPTH** key is pressed.

The depth information is only displayed when the Network DATA unit is connected to a Network QUAD or Network DEPTH unit. The depth units and the alarm values are set on the main unit.

When depth data is available the following can be displayed:

- **DEPTH M** Water depth in metres **M**, feet **FT**, fathoms **FA**.
- **DEP A M** Deep water alarm. The display will show the value or **OFF**.
- **SHA A M** Shallow water alarm. The display will show the value or **OFF**.
- **ANC A M** Anchor watch alarm. The display will show the values alternatively or **OFF**.

USING THE WIND KEY

Press the **WIND** key to cycle through the wind options.

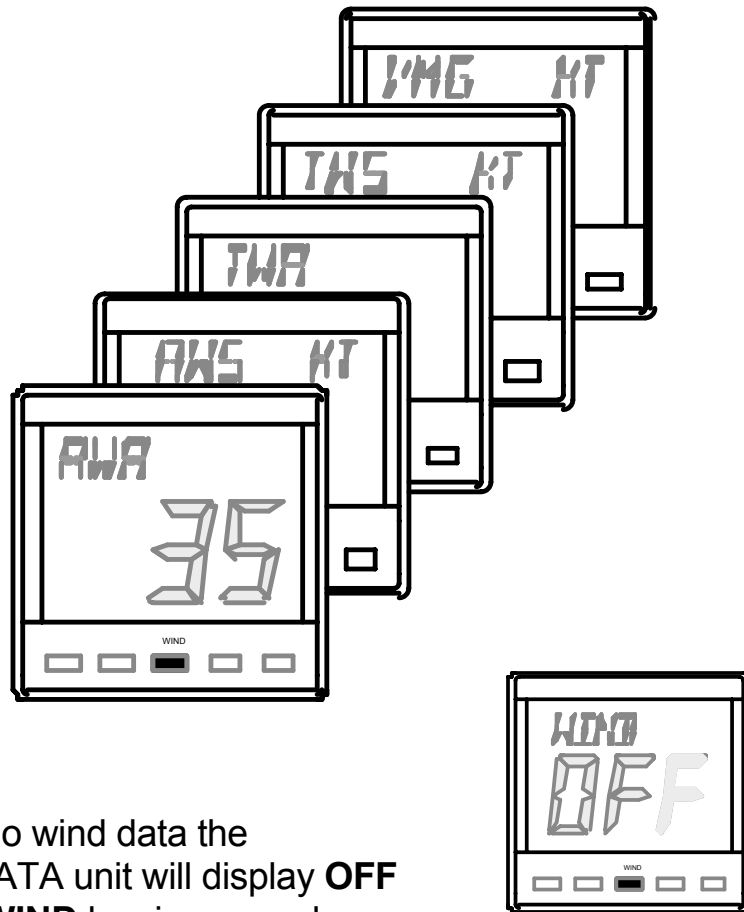

If there is no wind data the Network DATA unit will display **OFF** when the **WIND** key is pressed.

Apparent wind functions are displayed when Network DATA unit is connected to a Network WIND unit, true wind and VMG also require a Network SPEED unit.

When wind and speed data is available the following can be displayed:

AWA Apparent wind angle in degrees.

AWS KT Apparent wind speed in knots **KT**.

TWA True wind angle in degrees.

TWS KT True wind speed in knots **KT**.

VMG KT Velocity Made Good in knots **KT**.

AWA and **TWA** are indicated to Port or to Starboard by the position of the displayed legend.

PORT

STARBOARD

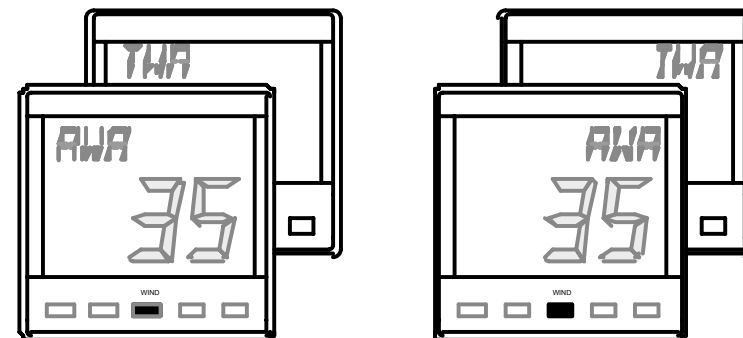

USING THE OPTIONS KEY

Press the **OPTIONS** key to cycle through the options.

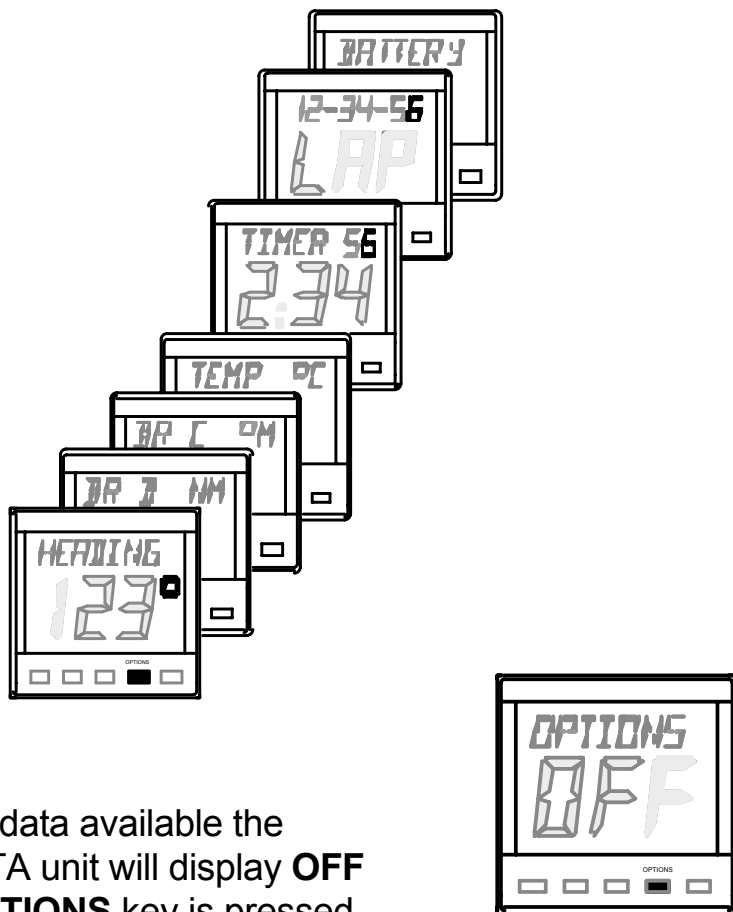

If there is no data available the Network DATA unit will display **OFF** when the **OPTIONS** key is pressed.

The information is only displayed when the Network DATA unit is connected to Network PILOT and Network SPEED or Network QUAD units.

When connected to the appropriate units the following can be displayed:

HEADING Compass heading supplied from Network PILOT's internal fluxgate compass.

DR D NM Dead Reckoned Distance in **NM** or **M**.

DR C °M Dead Reckoned Course in degrees Magnetic **M**.

TEMP °C Sea water temperature in degrees Celsius **C** or Fahrenheit **F**.

TIMER Timer, Hours and Minutes in large digits, Seconds in small digits.

LAP Lap timer, reset on main unit.

BATTERY Battery volts.

USING THE LIGHTS KEY

The Network DATA Display unit has 3 levels of illumination and off, controlled by the **LIGHTS** key.

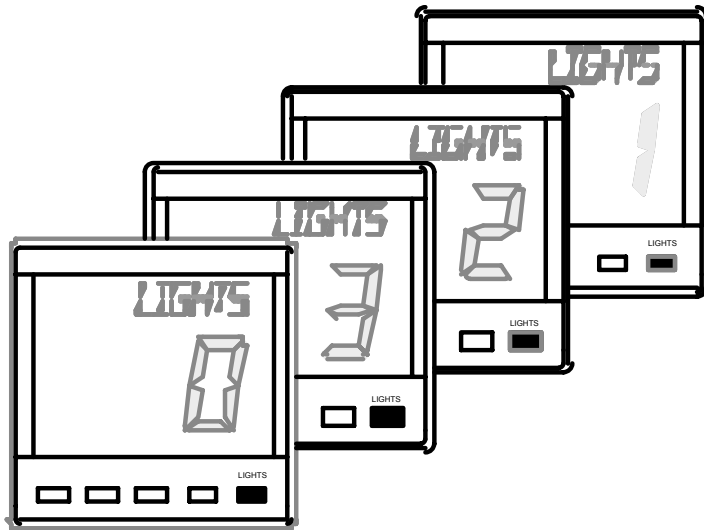

- **LIGHTS 0** OFF
- **LIGHTS 3** High
- **LIGHTS 2** Medium
- **LIGHTS 1** Low

It also changes the illumination level of the key legends.
The **LIGHTS** key is always illuminated so even in complete darkness the key can be located.

NETWORK ALARMS

The Network DATA unit has an internal buzzer that will sound when an alarm condition is met on a Network unit that has alarm functions ie. Network DEPTH and Network QUAD for depth alarms and Network PILOT for Watch Alarm and Off Course alarms. The unit will also display which alarm is activated.

To silence the internal alarm and return the display to normal operation press any of the five keys.

DEPTH ALARM DISPLAY

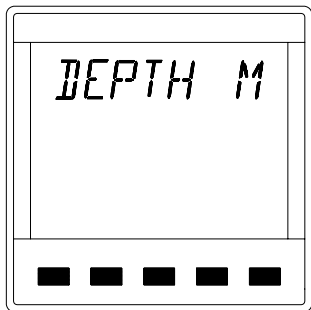

Depth alarms can be set for the following:

Shallow water

Deep water

Anchor Watch

Check your Network DEPTH or QUAD unit to see which alarm is activated.

NETWORK PILOT ALARM DISPLAYS



The Watch Alarm is a count-down timer with is activated at the end of the preset count-down period. The display alternates between the messages above.

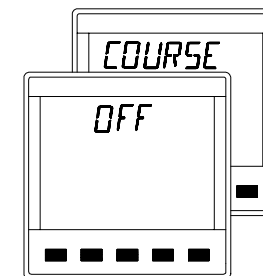

The Off Course alarm is activated when the boat deviates off course by a preset amount. The display alternates between the messages above.

FAULT AND ERROR MESSAGES

NETWORK PILOT FAULT DISPLAY

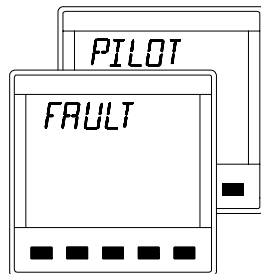

If Network PILOT should have a fault the autopilot computer unit will send a message to all other Network Display Units. The Network DATA unit will alternately display the follow message, the actual fault will have to read from the Network PILOT Display unit.

UNIT INTERNAL ERRORS

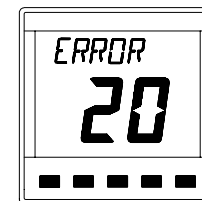

In the unlikely event that your Network DATA unit should develop an internal error, the unit will sound it's alarm continuously and the display will show an error number. Pressing the keys will not silence this alarm.

In some cases the fault can be cleared by switching off the instruments at the supply, waiting a few moments and then switching on again. If this does not clear the fault the error number should be recorded.

Switch off the supply and disconnect the faulty unit. Return it with the error number to your dealer for servicing.

INSTALLATION

The display heads are supplied with a clip-in mounting bracket which allows for easy installation, access from behind is not necessary to secure the unit in place. However to prevent theft and permanently fix the unit in position, locking studs and thumb nuts are supplied.

SITING THE UNIT

All Network Instruments are designed for mounting on or below deck. A mounting position should be selected where they are:

- Easy to read by the helmsman
- On a smooth and flat surface
- At least 100mm (4") from a compass
- Accessible from behind for fitting locking studs if required.

MOUNTING THE UNIT

Use the cutting template supplied to mark the centres of the holes for the self-tapping screw, the fixing stud holes and the mounting bracket.

- The template allows 4mm (5/32") between adjacent units for the suncover, increase this distance if required to maximum of 60mm (2 3/8") between units or 180mm (3 1/8") between centres. For greater distances between units extension cables are available.
- Use a 70mm (2 3/4") diameter hole-cutter for the mounting bracket hole.
- Use a 2.9mm for the self-tapping screw holes.
- Use a 5mm (3/32") drill for the locking stud holes.
- Secure the mounting bracket to the bulkhead with the self-tapping screws supplied
- Fit the rubber sealing gasket around the mounting bracket.
- Screw the locking studs into the back of the display head (if required).
- Carefully pass the cable tails through the mounting bracket hole, connect the cables to the main units.
- Clip the display head into the mounting bracket.
- Secure the instrument with the thumb nuts supplied.

INSTALLATION

DATA Display Unit

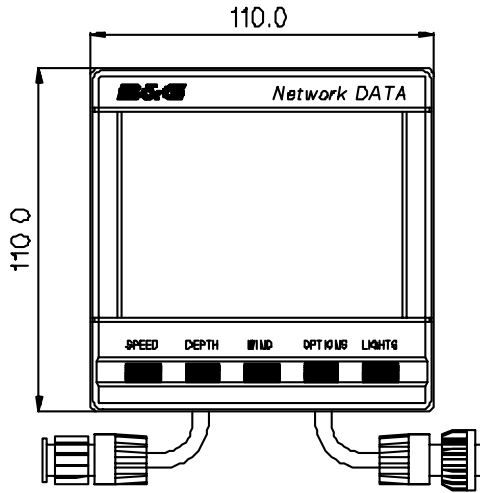

Side view of unit

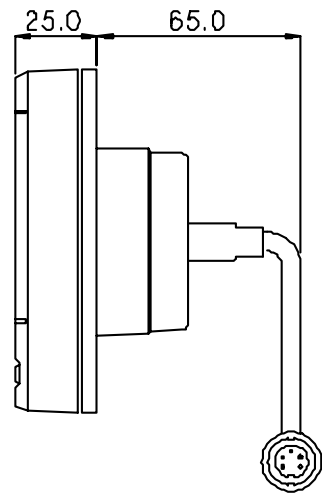

Rear view of unit

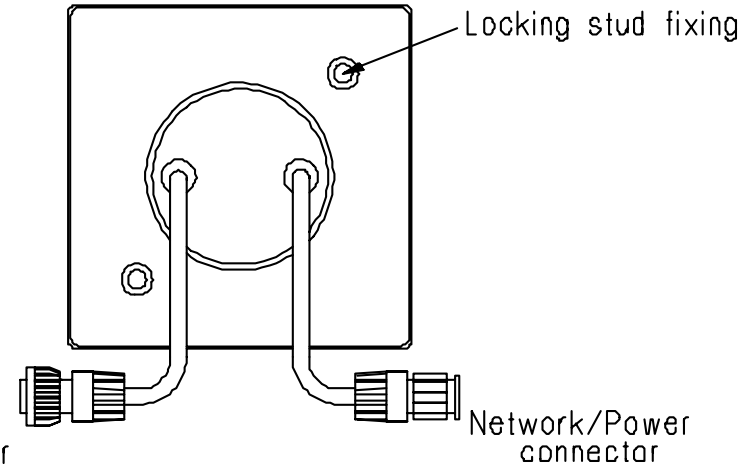

Mounting Bracket

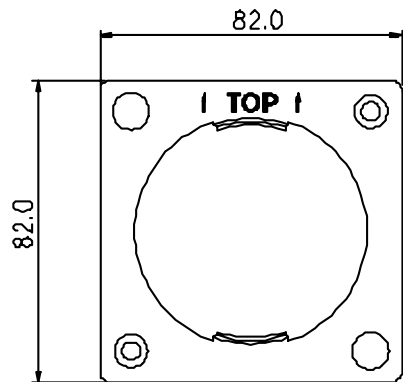

Rubber Gasket

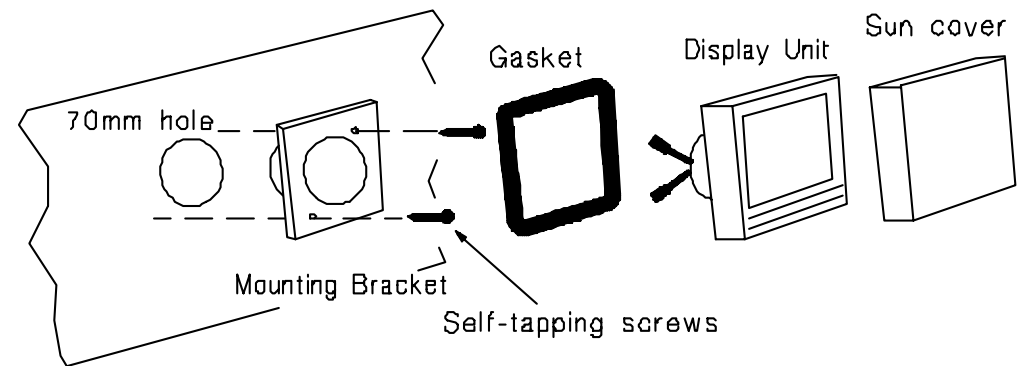
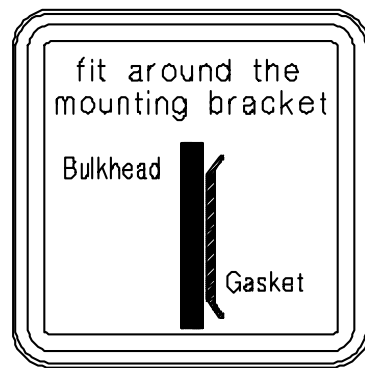

All Dimensions in millimeters

SPECIFICATION

PHYSICAL PARAMETERS

| | |
|--------------------|---|
| Constuction | High impact ABS plastic |
| Window | Acrylic |
| Display | Back-lit Liquid Crystal Display: Large Digits: 28.6mm 1.12" Small Digits: 11.5mm 0.45" |
| Dimensions | 110 x 110 x 25.4mm 4 x 4 x 1" Requires 65mm 2.6" depth behind bulkhead for display barrel |
| Weight | 0.3 kg 0.66lbs |

ENVIRONMENTAL

| | |
|-----------------------|--|
| Operating Temp | -10 to +55 ⁰ C @ 93%RH +14 to +131 ⁰ F @ 93%RH |
| Storage Temp | -25 to +70 ⁰ C @ 95%RH -13 to +158 ⁰ F @ 93%RH |
| Humidity | Up to 95%RH |
| Sealing | Fully sealed front, suitable for bulkhead cockpit mounting. Vented barrel to prevent condensation. |

ELECTRICAL

| | |
|--------------------------|--|
| Power Supply | 12V DC nominal (10 to 16V) |
| Operating Current | 40mA typical, 100mA illuminated |
| Protection | Connect via external fuse or circuit breaker. |

CABLES AND CONNECTIONS

Connection to adjacent units is via cable tails fitted with either a plug or a socket. Extension cables are available from your dealer. The cable tails carry power and NMEA data between units.

ALARM

Internal audible alarm

NMEA OUTPUT SENTENCES

| | |
|---------|-------------------------------|
| \$IIHDM | Heading |
| \$IIVHW | Speed and Heading |
| \$IIDBT | Depth |
| \$IIVWR | Apparent wind angle and speed |
| \$IIMTW | Sea temperature |