

# CONTENTS

|  |    |
|--|----|
| <b>CONTENTS</b> .....                                | 1  |
| <b>GENERAL INTRODUCTION TO B&amp;G NETWORK</b> ..... | 2  |
| <b>INTRODUCTION TO NETWORK NAV</b> .....             | 3  |
| <b>NETWORK NMEA INTERFACING RULES</b> .....          | 5  |
| <b>SYSTEMS WITH MULTIPLE NAV UNITS</b> .....         | 5  |
| <b>INTERFACING NETWORK NAV AND PILOT</b> .....       | 6  |
| <b>EXAMPLE SYSTEMS USING NETWORK NAV</b> .....       | 7  |
| <br>   |    |
| <b>USING THE COG/SOG KEY</b> .....                   | 8  |
| <br>   |    |
| <b>USING THE BTW/DTW KEY</b> .....                   | 9  |
| <br>   |    |
| <b>USING THE OPTIONS KEY</b> .....                   | 10 |
| <br>   |    |
| <b>USING THE SETUP KEY</b> .....                     | 11 |
| SELECTING TRUE OR MAGNETIC BEARINGS .....            | 12 |
| SELECTING GREAT CIRCLE OR RHUMB-LINE .....           | 13 |
| SELECTING UNIVERSAL OR LOCAL TIME.....               | 14 |
| SELECTING THE NMEA DATA 183/180.....                 | 15 |

|   |    |
|---|----|
| <b>USING THE LIGHTS KEY</b> .....           | 16 |
| <br>  |    |
| <b>NETWORK ALARMS</b> .....                 | 17 |
| <b>FAULT AND ERROR MESSAGES</b> .....       | 19 |
| <br>  |    |
| <b>INSTALLATION</b> .....                   | 20 |
| SITING THE UNIT .....                       | 20 |
| MOUNTING THE UNIT.....                      | 20 |
| <br>  |    |
| <b>SPECIFICATION</b> .....                  | 22 |
| NAV NMEA 0183 (v1.5) SENTENCE SUMMARY ..... | 23 |
| <br>  |    |
| <b>GLOSSARY AND ABBREVIATIONS</b> .....     | 24 |

## **GENERAL INTRODUCTION TO B&G NETWORK**

The B&G Network range of instruments is designed for use as individual units or connected together to form an integrated navigational system. A single network cable is used to carry data and power between units. The latest technology and screened cables throughout the Network System ensure the ultimate protection from interference between units and other systems. All Network instruments can be linked to Network PILOT, Network CHART, Network GPS or Network LORAN receivers or via NMEA 0183 (v1.5) to other navigational equipment.

### **INSTRUMENTS**

Network SPEED  
Network DEPTH  
Network QUAD  
Network WIND  
Network TACK  
Network DATA

### **NAVIGATIONAL AIDS**

Network GPS  
Network LORAN  
Network NAV  
Network CHART

### **AUTOPILOTS**

Network PILOT

### **COMMUNICATIONS**

Network VHF

## INTRODUCTION TO NETWORK NAV

The Network NAV unit will act as an on-deck display head of information supplied from any NMEA 0183 (v1.5) compatible position fixer, i.e. GPS, Decca or Loran C. This information is presented on a large back-lit Liquid Crystal Display (LCD).

It can be connected directly to the position fixer via its' NMEA interface connector, at the rear of the unit, or as a repeater of information supplied via the network cables from other NAV units when part of an integrated Network System. The NMEA information is translated on to the system network and sent to other Network units, e.g. Cross Track Error (XTE) used by the Network PILOT.

The Network NAV unit has an internal alarm buzzer that sounds when an alarm condition is met either on the unit or other Network units in an integrated Network System.

The rows of five keys are used to select the displayed information and change the operating parameters of the NAV unit. A brief summary follows:

- **COG/SOG** Course Over Ground, Speed Over Ground
- **BTW/DTW** Bearing to Waypoint, Distance to Waypoint
- **OPTIONS** XTE, Course to Steer, Time to Waypoint, Waypoint Identity, Latitude and Longitude
- **SETUP** Select data source, magnetic or true bearing, Great Circle or Rhumb distance, Arrival Alarm
- **LIGHTS** Three levels of illumination and off.

## NETWORK NAV DISPLAY UNIT

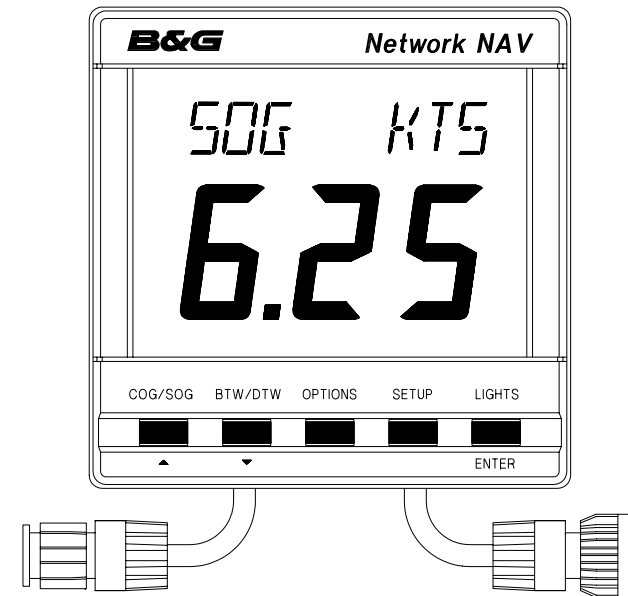

## INTRODUCTION TO NETWORK NAV

### IMPORTANT NOTE

It is important to remember that the Network NAV unit is only a display head for any compatible position fixer. Any erratic or positional errors generated by the position fixer due to poor reception, bad satellite constellation or radio beacon chain transitions, will be displayed on the Network NAV and also transmitted to your Network PILOT, if the NAV is part of a system containing an autopilot. It is strongly recommended that an accurate log and positional plot be maintained on a current chart.

Before using Network NAV for navigation or supply of data to Network PILOT, check the following:

- The position fixer has a compatible NMEA 0183 (v1.5) interface, set-up and connected in accordance with the manufacturers' instructions.
- It is switched on and has the correct current position.
- The signal and noise levels are within the manufacturers' recommended levels.
- The waypoints have been entered correctly, and the waypoint arrival alarm switched on (if it has one).
- If using waypoints in a Route or Sail (cruise) Plan, they are entered correctly and the route is enabled.

## NETWORK NMEA INTERFACING RULES

The following rules apply to all Network Systems interfacing with any NMEA 0183 (v1.5) device, e.g. GPS, Decca, Loran C, and Chart Plotters.

- There can only be one of each of the following position fixer types connected to a Network System:
  - GPS, Decca and Loran C.
- The Network System only allows one source of information for any given NMEA function, transmitted onto the network, e.g. there can be only one XTE supplied from the device selected.
- When a Network System contains a Network PILOT, with a display head, and a Network NAV unit, the NMEA input on the Network PILOT display head CANNOT be used.
- When the Network PILOT is engaged it is NOT possible to change the source of NMEA information, e.g. it is not possible to change from GPS to Loran C (or Decca) without disengaging the Network PILOT.

## SYSTEMS WITH MULTIPLE NAV UNITS

The Interfacing Rules described previously must be appreciated when using multiple Network NAV units in a Network System. Additionally the following applies:

- Up to four NAV units may be fitted on a Network System. A NAV unit connected to a position fixer automatically acts as the master unit, any other units NOT connected to position fixers, act as repeaters.
- It is possible for a Network System to contain more than one master NAV unit, i.e. one could be connected to a GPS and another to a Decca (or Loran C). When a NAV unit is connected to a position fixer it will declare its type by transmitting a short message on to the system network. **GP** = GPS, **DC** = Decca, **LC** = Loran C.
- As the Network rules only allow one source of NMEA information the transmitting master NAV unit connected to its position fixer, must be selected using the **SETUP** key. The type of position fixer selected is identified on the LCD (Refer to Using The SETUP Key).
- Only one of each type of position fixer is allowed.

## INTERFACING NETWORK NAV AND PILOT

### IMPORTANT NOTE

- A Network System cannot be constructed where one position fixer is connected via the PILOT display unit NMEA input socket and another via the NAV unit interface. This is an invalid configuration.
- If two (different) position fixers are required it is always necessary to use two NAV units.
- The Network PILOT Display and Computer unit will use NMEA information from whichever position fixer is selected.
- The source of the NMEA information can only be selected using a NAV unit. The NAV1 and NAV2 options on the Network PILOT display are no longer valid.
- If the NAV unit is to be added to an existing system containing a Network PILOT display, interfaced to an NMEA position fixer via the NMEA input, it will be necessary to transfer the NMEA input from the PILOT display to the NAV unit.

# EXAMPLE SYSTEMS USING NETWORK NAV

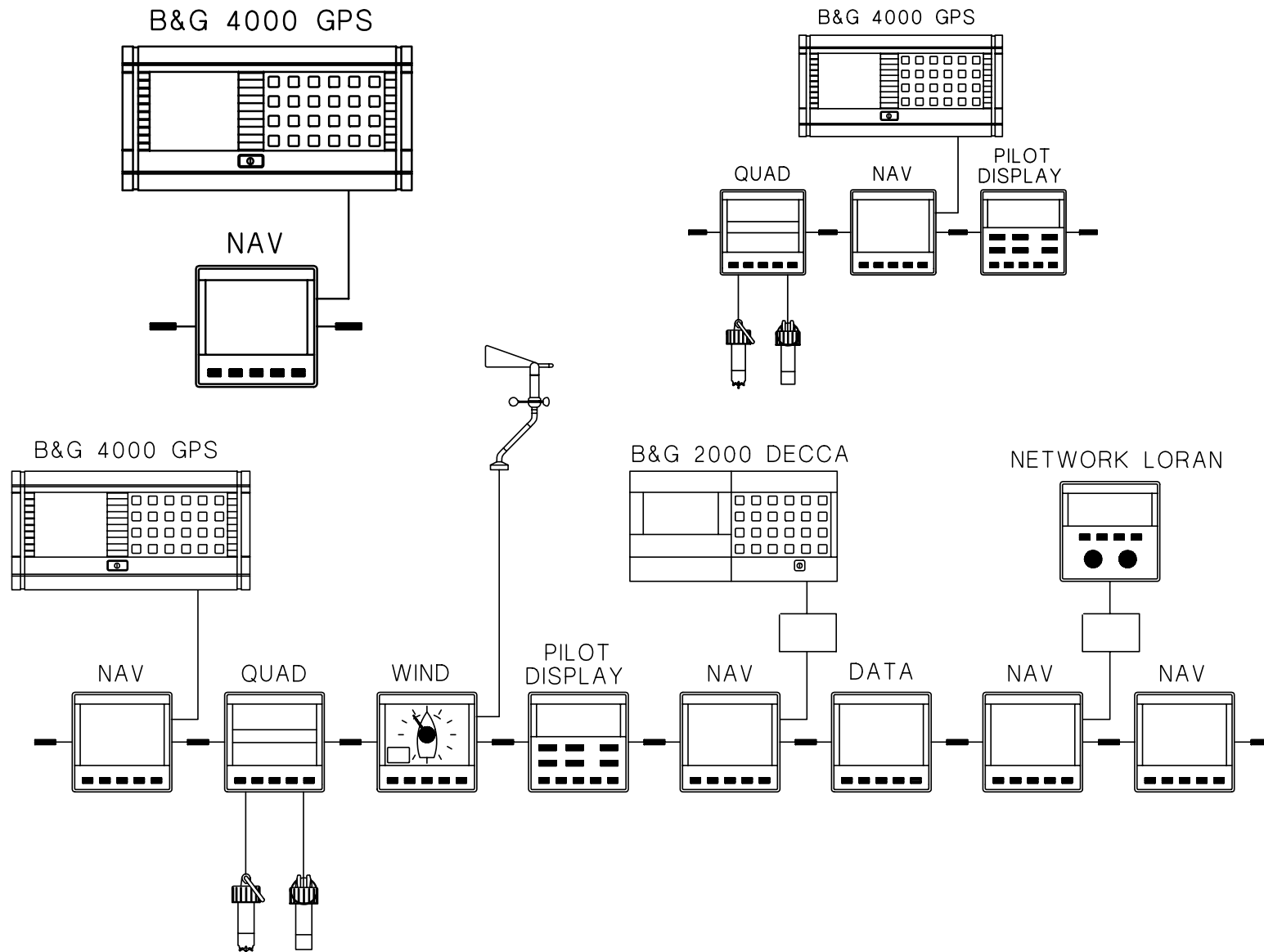

## USING THE COG/SOG KEY

Press the **COG/SOG** key to cycle through the following options.

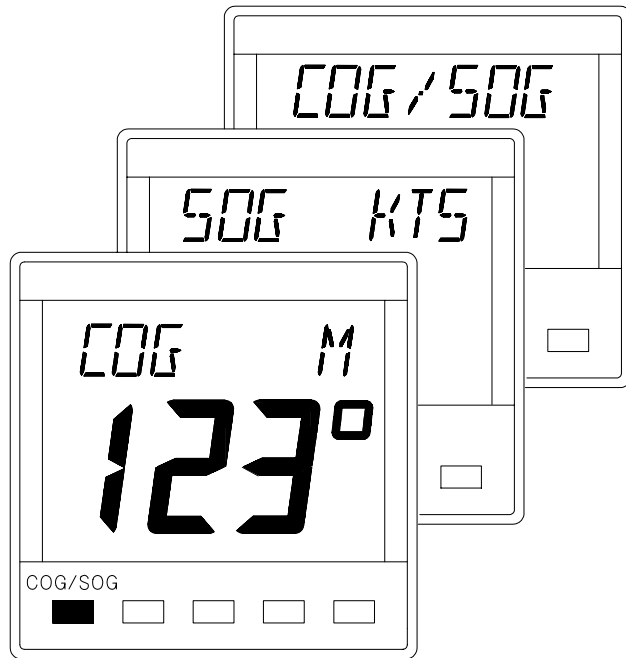

- **COG M** Course Over Ground, Magnetic.
- **SOG KTS** Speed Over Ground, SOG is always displayed in Knots **KTS**.
- **COG/SOG** The LCD will alternatively show COG, then SOG.

COG can be displayed as Magnetic **M** or True **T** bearings, selected using the **SETUP** key.

If there is no NMEA data available, the unit will display **OFF** when the **COG/SOG** button is pressed.



## USING THE BTW/DTW KEY

Press the **BTW/DTW** to cycle through the following options.



If there is no NMEA data available, the display will show **OFF** when the **BTW/DTW** button is pressed.

- **WPB GC M** Waypoint Bearing, Great Circle, Magnetic. This is displayed for 5 seconds only.
- **WPB NAME** Then Waypoint Bearing is displayed to the target waypoint, where "NAME" is the first 4 characters of the waypoint name or number, e.g. "JACKSON" would be displayed as "JACK".
- **WPD GC** Waypoint Distance, Great Circle. This is displayed for 5 seconds only.
- **WPD NAME** Then Waypoint Distance is displayed to the target waypoint, where "NAME" is as above.
- **B/D NAME** Bearing and Distance are alternatively displayed to the target waypoint.

Waypoint Bearing can be displayed as Magnetic **M** or True **T**, selected using the **SETUP** key.

Waypoint Distance can be displayed as Great Circle **GC** or Rhumb-line **RH**, selected using the **SETUP** key.

## USING THE OPTIONS KEY

Use the **OPTIONS** key to cycle through the following options.



If there is no NMEA data available, the display will show **OFF** when the **OPTIONS** key is pressed.

- **WP NAME** The identifying name or number of the target waypoint, where "NAME" is the first 4 characters of the waypoint name or number, e.g. "JACKSON" would be displayed as "JACK".
- **TTG HRS** Time To Go to the target waypoint in hours.
- **XTE** † Cross Track Error, with steering indicator.  
‡ steer to port, † steer to starboard.
- **CTS M** Course To Steer, Magnetic **M**, to the target waypoint.
- **VMG NAME** Velocity Made Good to "NAME".
- **LAt/LOn** Alternating display of present Latitude and Longitude.
- **UTC** Universal Time Coordinated, can also be selected to display Local Time **LT**, if available from the position fixer.

## USING THE SETUP KEY

The **SETUP** key allows the Network NAV operating parameters to be set.

Press the **SETUP** key to cycle through the following options.

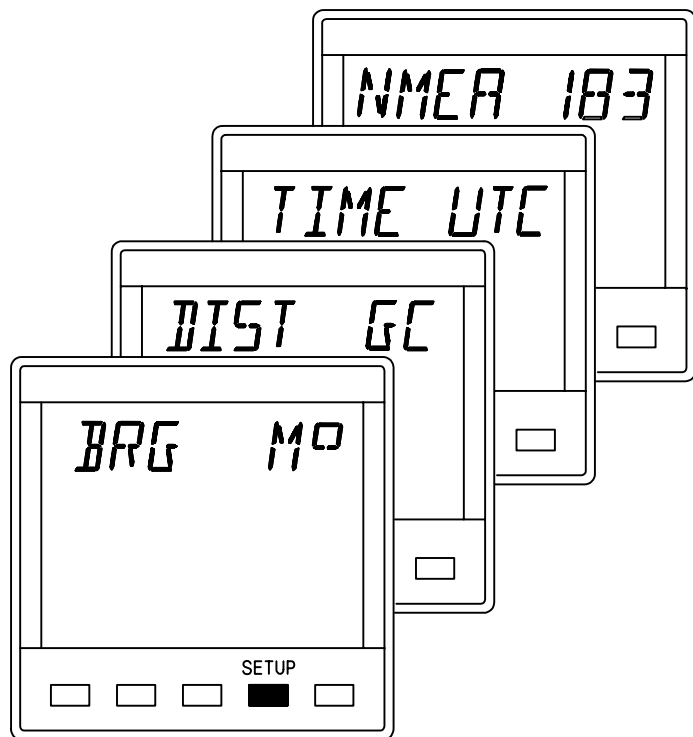

- **BRG M<sup>0</sup>** The displayed bearing reference, either Magnetic **M** (factory set), or True **T**.
- **DIST GC** The displayed distance method of calculation, either Great Circle **GC** (factory set), or Rhumb Line **RH**.
- **TIME UTC** Selects Universal Time Coordinated **UTC** (factory set), or Local Time **LT**.
- **NMEA 183** NMEA Data selection NMEA 0183 (V1.5) or NMEA 0180.

## SELECTING TRUE OR MAGNETIC BEARINGS

The Network NAV can show bearing in degrees referenced to Magnetic **M** or True **T** North. The unit is factory set to Magnetic. The selected reference is for all Nav units on the whole Network System.

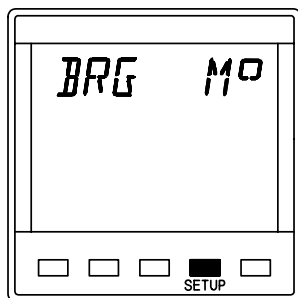

Press **SETUP** key until **BRG M°** is displayed.

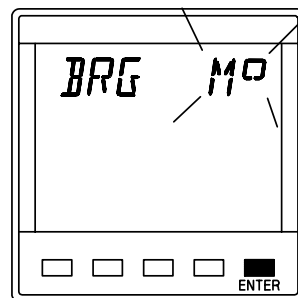

Press **ENTER** key, the display will flash.

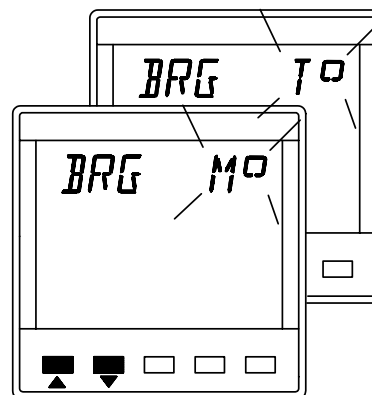

Use the ▲ or ▼ keys to change the bearing reference.

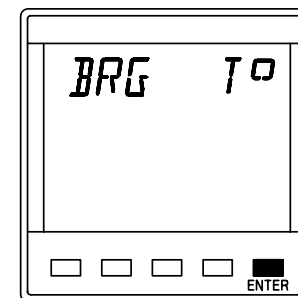

Press **ENTER** key to memorise the new setting.

## SELECTING GREAT CIRCLE OR RHUMB-LINE

The Network NAV can show Distances calculated either Great Circle **GC** or Rhumb-Line **RH**. The unit is factory set to Great Circle. The selected calculation is for all Nav units on the whole Network System.

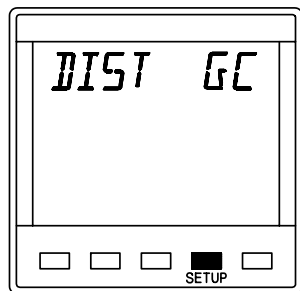

Press **SETUP** key until **DIST GC** is displayed.

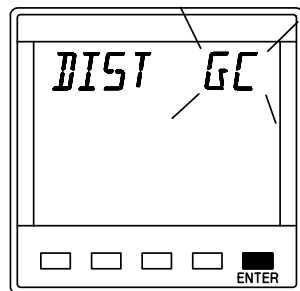

Press **ENTER** key, the display will flash.

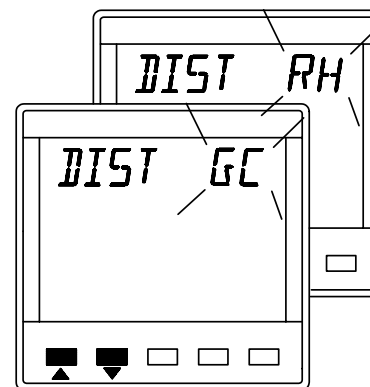

Use the ▲ or ▼ keys to change the distance display.

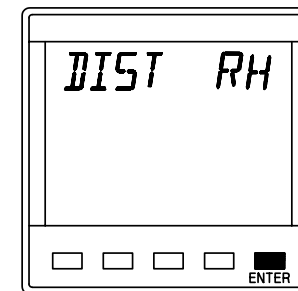

Press **ENTER** key to memorise the new setting.

## SELECTING UNIVERSAL OR LOCAL TIME

The Network Nav unit can display time either as Universal Time Coordinated **UTC** or as Local Time **LT**. UTC is transmitted by the satellites used for GPS, and has now superseded Greenwich Mean Time GMT. Local Time can be set on some GPS, Decca and LORAN C receivers, check your owner's manual.

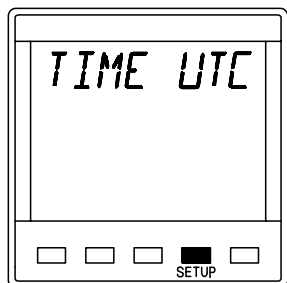

Press **SETUP** key until **TIME UTC** is displayed.

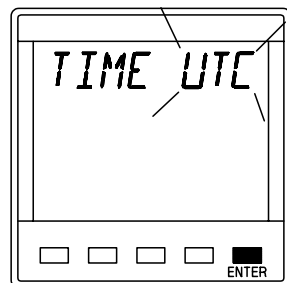

Press **ENTER** key, the display will flash.

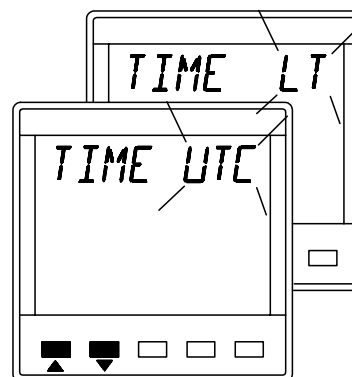

Use the ▲ or ▼ keys to change the displayed time.

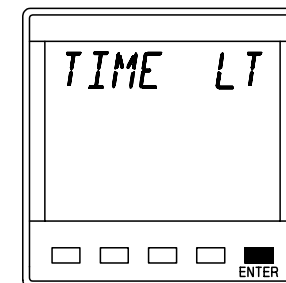

Press **ENTER** key to memorise the new setting.

## SELECTING THE NMEA DATA

This selection allows the NAV to translate early NMEA device output sentences for display. Modern equipment uses NMEA 0183 output sentences, early equipment may have used NMEA 0183. Consult the user manual for your equipment to determine the correct setting

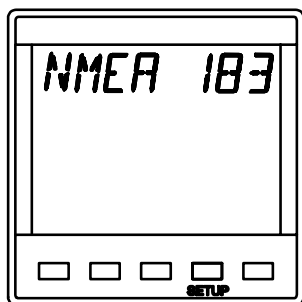

Press **SETUP** key until **NMEA 183** is displayed.

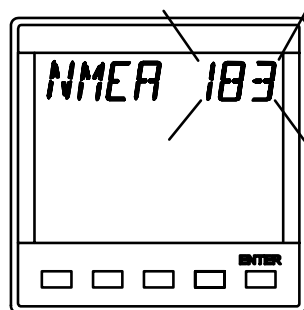

Press **ENTER** key, the display will flash.

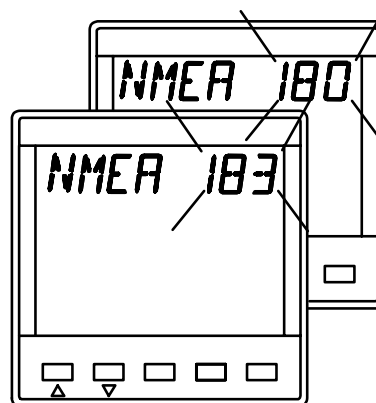

Use the ▲ or ▼ keys to change the NMEA data type.

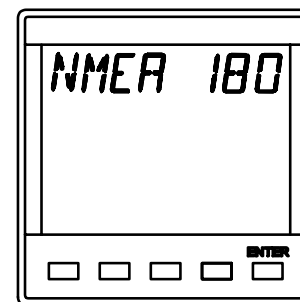

Press **ENTER** key to memorise the NMEA data type.

## USING THE LIGHTS KEY

The Network NAV Display unit has 3 levels of illumination and off, controlled by the **LIGHTS** key.

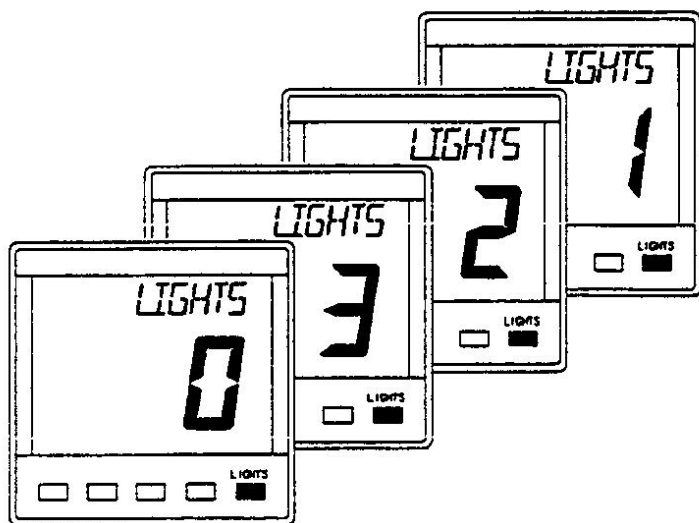

- **LIGHTS 0** OFF
- **LIGHTS 3** High
- **LIGHTS 2** Medium
- **LIGHTS 1** Low

It also changes the illumination level of the key legends. The **LIGHTS** key is always illuminated so even in complete darkness the key can be located.



## NETWORK ALARMS

The Network NAV unit has an internal buzzer that will sound when an alarm condition is met on a Network unit that has alarm functions i.e. Network DEPTH and Network QUAD for depth alarms and Network PILOT for Watch Alarm and Off Course alarms. The unit will also display which alarm is activated.

To silence the internal alarm and return the display to normal operation press any of the five keys.

### WAYPOINT ARRIVAL

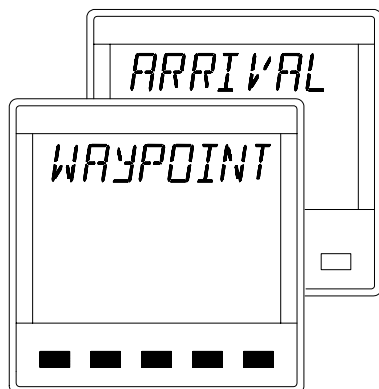

The Network Waypoint Arrival alarm is activated when an alarm signal is sent from the position fixer as the boat approaches the target waypoint that is currently selected. It will only sound if the arrival alarm is set and enabled on the position fixer.

### DEPTH ALARM DISPLAY

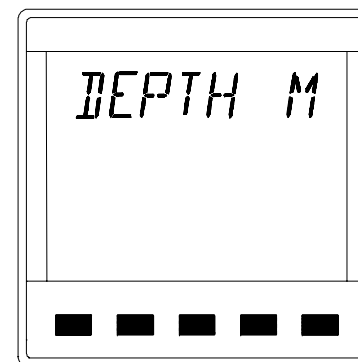

Depth alarms can be set for the following:

- Shallow water
- Deep water
- Anchor Watch
- Check your Network DEPTH or QUAD unit to see which alarm is activated.

## NETWORK ALARMS

### NETWORK PILOT ALARM DISPLAYS

#### WATCH ALARM

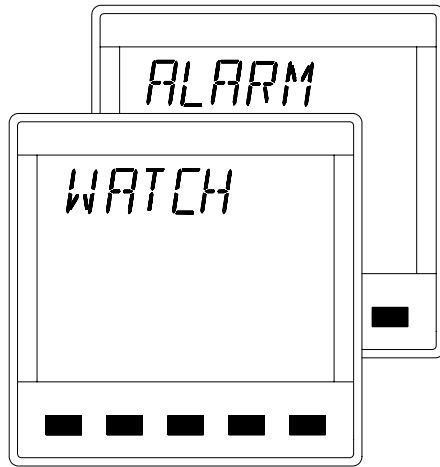

The Watch Alarm is a count-down timer which is activated at the end of the preset count-down period. The display alternates between the messages above.

#### OFF-COURSE ALARM

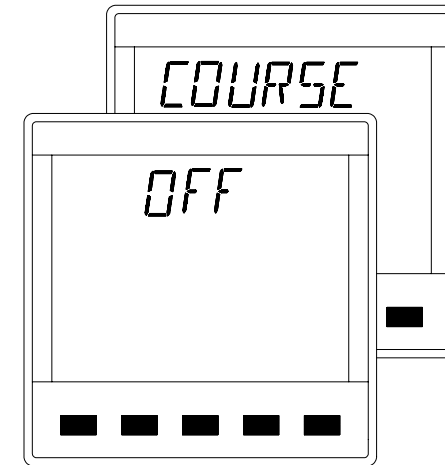

The Off Course alarm is activated when the boat deviates off course by a preset amount. The display alternates between the messages above.

## FAULT AND ERROR MESSAGES

### NETWORK PILOT FAULT DISPLAY

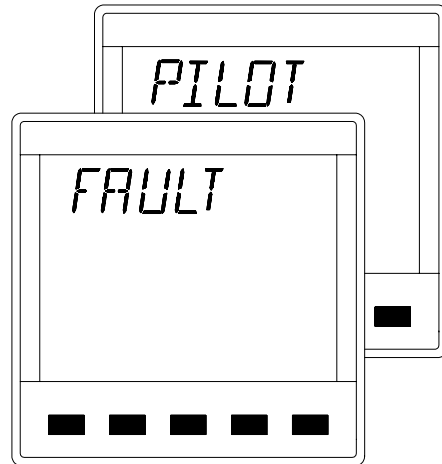

If Network PILOT should have a fault condition the autopilot computer unit will send a message to all other Network Display Units. The Network NAV unit will alternately display the following message, the actual fault will have to read from the Network PILOT Display unit.

### UNIT INTERNAL ERRORS

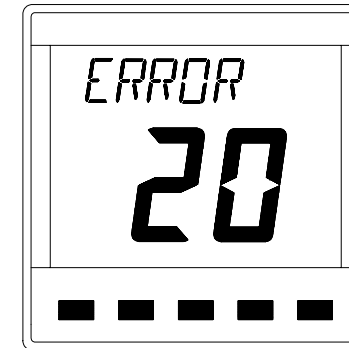

In the unlikely event that your Network NAV unit should develop an internal error, the unit will sound its alarm continuously and the display will show an error number. Pressing the keys will not silence this alarm.

In some cases the fault can be cleared by switching off the instruments at the supply, waiting a few moments and then switching on again. If this does not clear the fault the error number should be recorded.

Switch off the supply and disconnect the faulty unit. Return it with the error number to your dealer for servicing.

## INSTALLATION

The display heads are supplied with a clip-in mounting bracket that allows for easy installation, access from behind is not necessary to secure the unit in place. However to prevent theft and permanently fix the unit in position, locking studs and thumb nuts are supplied.

## SITING THE UNIT

All Network Instruments are designed for mounting on or below deck. A mounting position should be selected where they are:

- Easy to read by the helmsman
- On a smooth and flat surface
- At least 100mm (4") from a compass
- Accessible from behind for fitting locking studs if required.

## MOUNTING THE UNIT

Use the cutting template supplied to mark the centres of the holes for the self-tapping screw, the fixing stud holes and the mounting bracket.

- The template allows 4mm (5/32") between adjacent units for the sun cover, increase this distance if required to maximum of 60mm (2 3/8") between units or 180mm (3 1/8") between centres. For greater distances between units extension cables are available.
- Use a 70mm (2 3/4") diameter hole-cutter for the mounting bracket hole.
- Use a 2.9mm for the self-tapping screw holes.
- Use a 5mm (3/32") drill for the locking stud holes.
- Secure the mounting bracket to the bulkhead with the self-tapping screws supplied
- Fit the rubber-sealing gasket around the mounting bracket.
- Screw the locking studs into the back of the display head (if required).
- Carefully pass the cable tails through the mounting bracket hole, connect the cables to the main units.
- Clip the display head into the mounting bracket.
- Secure the instrument with the thumb nuts supplied.

# INSTALLATION

NAV Display Unit

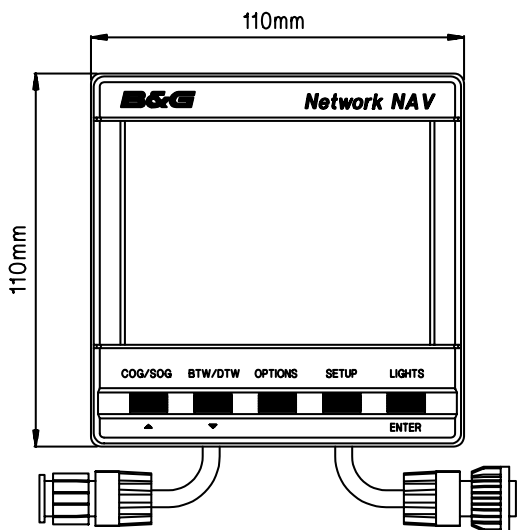

Side view of unit

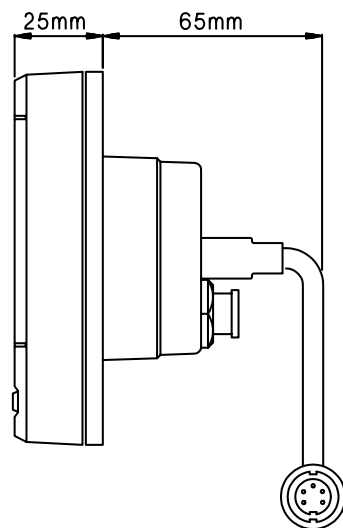

Rear view of unit

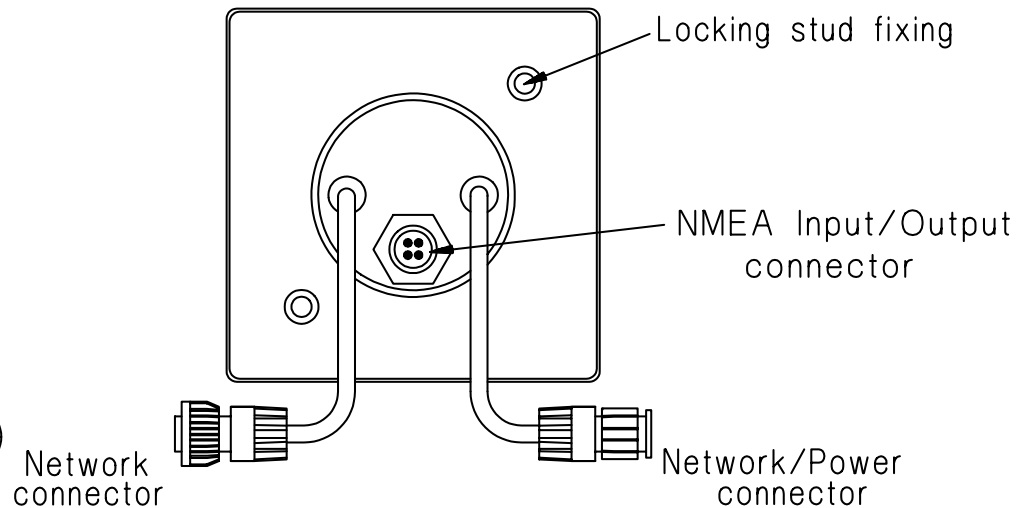

Mounting Bracket

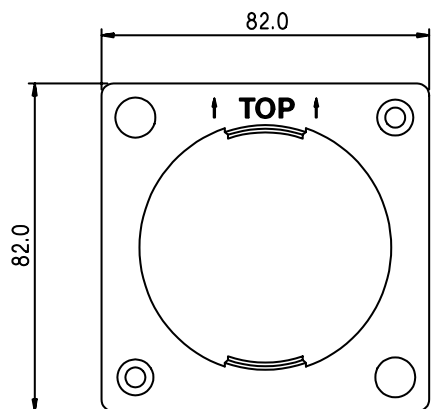

Rubber Gasket

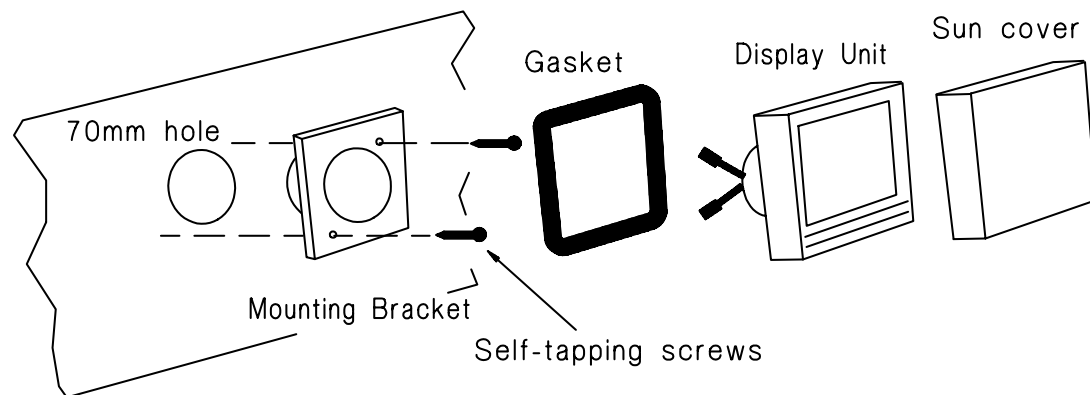
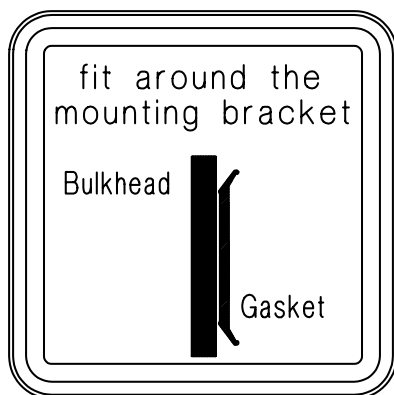

# SPECIFICATION

## PHYSICAL PARAMETERS

|                     |   |
|---------------------|---|
| <b>Construction</b> | High impact ABS plastic   |
| <b>Window</b>       | Acrylic   |
| <b>Display</b>      | Back-lit Liquid Crystal Display:<br>Large Digits: 28.6mm 1.12"<br>Small Digits: 11.5mm 0.45"    |
| <b>Dimensions</b>   | 110 x 110 x 25.4mm 4 x 4 x 1"<br>Requires 65mm 2.6" depth behind<br>bulkhead for display barrel |
| <b>Weight</b>       | 0.3 kg 0.66lbs  |

## ENVIRONMENTAL

|                       |  |
|-----------------------|--|
| <b>Operating Temp</b> | -10 to +55°C @ 93%RH<br>+14 to +131°F @ 93%RH  |
| <b>Storage Temp</b>   | -25 to +70°C @ 95%RH<br>-13 to +158°F @ 93%RH  |
| <b>Humidity</b>       | Up to 95%RH  |
| <b>Sealing</b>        | Fully sealed front, suitable for bulkhead<br>cockpit mounting. Vented barrel to<br>prevent condensation. |

## ELECTRICAL

|                          |  |
|--------------------------|--|
| <b>Power Supply</b>      | 12V DC nominal (10V to 16V)                      |
| <b>Operating Current</b> | 40mA typical, 100mA illuminated                  |
| <b>Protection</b>        | Connect via external fuse or<br>circuit breaker. |

## CABLES AND CONNECTIONS

Connection to adjacent units is via cable tails fitted with either a plug or a socket. Extension cables are available from your dealer. The cable tails carry power and NMEA data between units.

## ALARM

Internal audible alarm

## NAV NMEA 0183 (v1.5) SENTENCE SUMMARY

### NMEA INPUT SENTENCE (NETWORK DECODED DATA)

|         |   |
|---------|---|
| \$IDAAM | Arrival alarm, waypoint i.d.  |
| \$IDAPA | XTE, arrival alarm, waypoint i.d.                                       |
| \$IDAPB | XTE, bearing to waypoint, course to steer, arrival alarm, waypoint i.d. |
| \$IDBWC | Bearing and distance to waypoint, great circle measured, waypoint i.d.  |
| \$IDBWR | Bearing and distance to waypoint, rhumb measured, waypoint i.d.         |
| \$IDGLL | Latitude, Longitude.  |
| \$IDGGA | Latitude, Longitude (GPS only).   |
| \$IDGLP | Latitude, Longitude, waypoint id (Loran).                               |
| \$IDRMA | Latitude, Longitude, SOG, COG, variation (Loran).                       |
| \$IDRMB | XTE, bearing and distance to waypoint, VMG to waypoint, waypoint i.d.   |
| \$IDRMC | Latitude, Longitude, SOG, COG, variation, (GPS).                        |
| \$IDVHW | Boat speed.   |
| \$IDVTG | Actual track and ground speed.  |
| \$IDWCV | Velocity to Waypoint, waypoint identity.                                |
| \$IDXTE | Cross track error.  |
| \$IDZTG | Time to waypoint.   |

### NMEA OUTPUT SENTENCES

|         |                               |
|---------|-------------------------------|
| \$IIHDM | Heading, magnetic.            |
| \$IIVHW | Water speed and heading.      |
| \$IIDBT | Depth below transducer.       |
| \$IIVWR | Apparent wind angle and speed |
| \$IIMTW | Sea temperature, Celsius.     |

NOTE: "ID" is any one of the following NMEA devices  
GP=GPS, DC=Decca, LC=Loran C.

## GLOSSARY OF TERMS AND ABBREVIATIONS

BEARING The direction from one point to another.  
GREAT CIRCLE The shortest distance between two points on a globe.  
RHUMB-LINE The shortest distance between two points (straight-line).

AR Arrival (alarm)  
B/D Bearing/Distance (to waypoint)  
BRG Bearing  
BTW Bearing to waypoint, (waypoint bearing).  
COG Course Over Ground.  
CTS Course to Steer.  
D Demo (display type)  
DIST Distance  
DTW Distance to waypoint, (waypoint distance).  
E East  
GC Great Circle.  
GMT Greenwich Mean Time. Now superseded by UTC.  
GPS Global Positioning System.  
HRS Hours.  
KTS Knots, 1 Nautical mile per hour.  
LAt Latitude.  
LOn Longitude.

LT Local Time.  
M Magnetic (bearing reference).  
N Normal (display type), North when used with LAt or LOn  
NMEA National Marine Equipment Association of America.  
RH Rhumb-line.  
S South  
T True (bearing reference).  
TTG Time to Go (to waypoint).  
UTC Universal Time Co-ordinated. Supersedes GMT. Greenwich Mean Time  
VMG Velocity Made Good.  
W West  
WP Waypoint  
WPB Waypoint Bearing  
WPD Waypoint Distance.  
XTE Cross Track Error.